

# Parti per ..... t/cuci (Organi di cucitura principali)

# JUKI

per : MO-3614; MO-3714; MO-3914 (-BE6) 4 fili

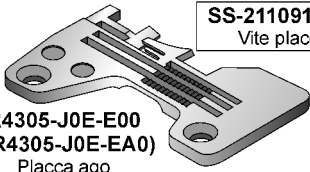

**SS-2110910-SL**  
Vite placca

**R4305-J0E-E00**  
(=R4305-J0E-EA0)  
Placca ago



**118-76869**  
Piedino premistoffa  
(=118-76851)

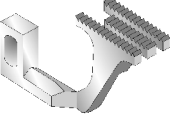

**119-49906**  
Griffa differenziale  
**SS-9111010-SP**  
Vite griffa

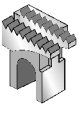

**119-49807**  
Griffa principale  
**SS-9111050-SP**  
Vite griffa



**118-87106**  
Griffa ausiliaria  
**SS-4080610-SP**  
Vite griffa

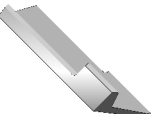

**118-45807**  
Coltello superiore

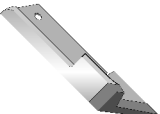

**118-45807(CT)**  
Coltello superiore  
in VIDIA



**B4111-804-00E(CT)**  
Coltello sup.in VIDIA  
(per materiali pesanti)

**SS-9111610-SP** Vite coltello superiore



**118-45609(CT)**  
Coltello superiore  
in VIDIA  
**SS-9090813-TP**  
Vite coltello



**118-46003**  
Coltello inferiore  
**SS-9111010-SP**  
Vite coltello



**121-48706**  
Morsetto (2 aghi)  
**SS-8080310-TP**  
Vite ago

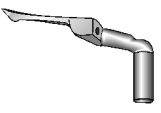

**121-76004**  
Crochet superiore  
**SS-9110430-TP**  
Vite crochet



**119-99307**  
Crochet inferiore  
**SS-6090620-SP**  
Vite crochet

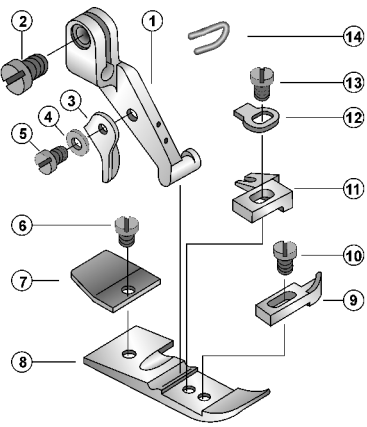

1 - 118-72009	Braccetto piedino	8 - B1507-814-00P	Suola
2 - SS-6090650-SP	Vite braccetto	9 - B1510-814-000	Salva ricciolo
3 - B1530-804-000	Aletta di fermo	10 - SS-6060440-TP	Vite salva ricciolo
4 - WP-0250516-SD	Rondella	11 - B1509-814-00P	Linguetta per punto
5 - SS-7060610-SP	Vite aletta	12 - B1508-804-00B	Molla
6 - SS-6060210-SP	Vite coda	13 - SS-7080520-SP	Vite molla
7 - B1511-814-000	Coda piedino	14 - 118-20701	Salvadita

**118-76869**  
Piedino premistoffa completo

per : MO-3616; MO-3716; MO-3916 (-DE4) 5 fili

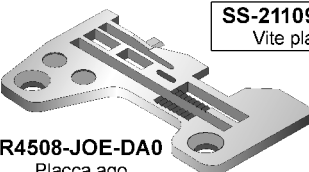

**SS-2110910-SL**  
Vite placca

**R4508-J0E-DA0**  
Placca ago



**121-53755**  
Piedino premistoffa  
(=121-53763)

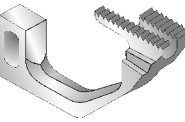

**121-72805**  
Griffa differenziale  
**SS-9111010-SP**  
Vite griffa

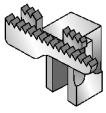

**118-82800**  
Griffa principale  
**SS-9111050-SP**  
Vite griffa



**118-87403**  
Griffa ausiliaria  
**SS-4080610-SP**  
Vite griffa



**118-45906**  
Coltello superiore

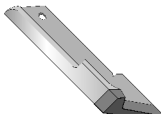

**118-45906(CT)**  
Coltello superiore  
in VIDIA



**B4111-804-00E(CT)**  
Coltello sup.in VIDIA  
(per materiali pesanti)

**SS-9111610-SP** Vite coltello superiore



**118-45708(CT)**  
Coltello superiore  
in VIDIA  
**SS-9090813-TP**  
Vite coltello



**118-46003**  
Coltello inferiore  
**SS-9111010-SP**  
Vite coltello



**121-49803**  
Morsetto (2 aghi)  
**SS-8080310-TP**  
Vite ago

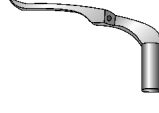

**118-88104**  
Crochet superiore  
(filati mediofini)  
**SS-9110430-TP** Vite crochet superiore

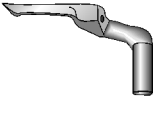

**119-99208**  
Crochet superiore  
(filati grossi)



**119-99307**  
Crochet inferiore  
**SS-6090620-SP**  
Vite crochet

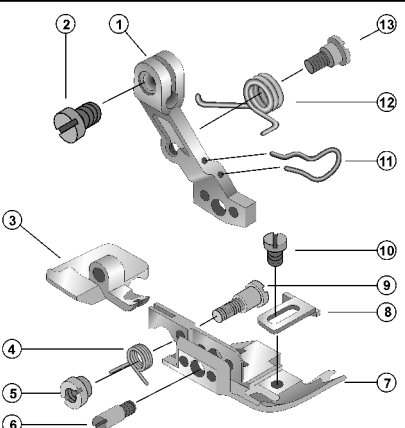

1 - 121-56907	Braccetto piedino	8 - 121-67706	Salva ricciolo
2 - SS-6090650-SP	Vite braccetto	9 - B1514-816-000	Perno posteriore
3 - 121-64802	Coda piedino	10 - SS-6060340-SP	Vite salva ricciolo
4 - 121-67805	Molla per coda	11 - 121-15408	Salvadita
5 - B1513-816-000	Dado	12 - 121-67607	Molla braccetto
6 - 121-67409	Perno anteriore	13 - 121-67508	Vite molla
7 - 121-62202	Suola		

**121-29405**  
Crochet anteriore  
(MO-3616)  
**SS-9110430-TP**  
Vite crochet

**121-20705**  
Crochet anteriore  
(MO-3716; MO-3916)  
**SS-6090620-TP**  
Vite crochet

**121-53755**  
Piedino premistoffa completo  
(=121-53763)