

# Articoli da pelletteria

(Leather goods items)

Siamo in grado di fornire articoli diversi  
per la pelletteria e calzatura.  
Contattateci per ogni vostra necessita'  
(www.brunoanichini.it)

We are able to supply different items  
for leather goods and shoes industry.  
Contact us for all your requirements  
(www.brunoanichini.it)

Portanastr  
*Tape reel stands*

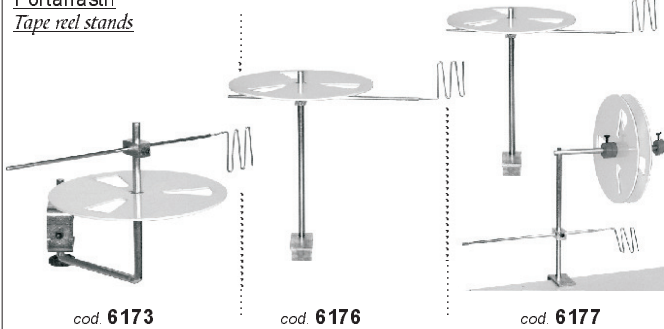

cod. 6173

cod. 6176

cod. 6177

Forbici rasafilo  
*Thread trimmer scissor*



cod. 1947

Forbici da lavoro  
*Work scissor*



cod. 5135KAI 135 mm  
cod. 5165KAI 165 mm

Righe acciaio  
*Stainless steel rules*

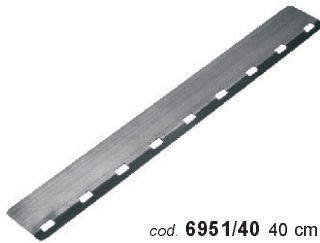

cod. 6951/40 40 cm  
cod. 6951/60 60 cm  
cod. 6951/80 80 cm

Compasso con guida  
*Compass with guide*

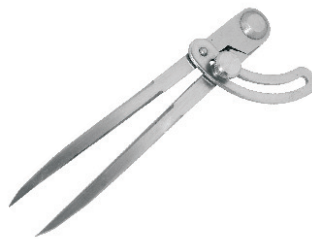

cod. U5210

Pinza con martelletto  
*Hammering plier*



cod. U1630

Spessimetro  
*Thickness gauge*



cod. U5200

Cote pietra naturale  
*Natural sharpening stone*

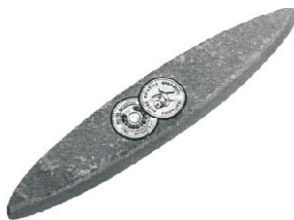

cod. 7100

Pinza apricorniera  
*Zip opener plier*

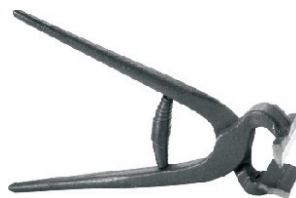

cod. U1610

Pinza chiudicorniera  
*Zip closer plier*

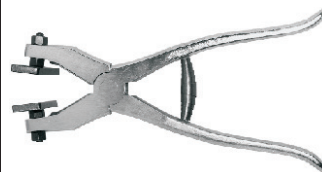

cod. U1620

Fustellatrice  
*Hollow puncher*

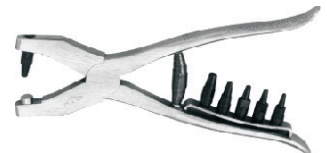

cod. 6863

Rotoli teflon adesivo  
*Teflon adhesive tape rolls*



cod. TR08 - 2,5x0,08 cm x 10 mt  
cod. TR13 - 2,5x0,13 cm x 10 mt

Teflon adesivo a strisce  
*Teflon adhesive tape*



cod. TS05 - 2,5x0,5 cm x 1,2 mt  
cod. TS10 - 2,5x1,0 cm x 1,2 mt  
cod. TS15 - 2,5x1,5 cm x 1,2 mt

Lattice puro 62%  
*Pure latex 62%*



cod. 710/..77100 - 5 Kg

Termoplastico  
*Thermoplastic*



cod. 710/..77120 - 1 Kg

Anelli abrasivi 440x35 mm  
*Abrasive bands 440x35 mm*



cod. 730/..20120 - anello gr.100  
cod. 730/..20130 - anello gr.120  
cod. 730/..20140 - anello gr.150

Lama per scarnitrice  
*Skiving machine blade*



cod. 730/..20010 lama "FORTUNA"  
"FORTUNA" blade  
cod. 730/..20020 lama standard  
standard blade

Mole 70x7 per scarnitrice  
*Grinding wheel 70x7 for skiving machine*

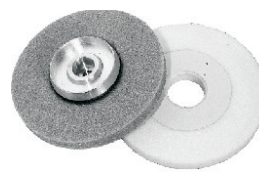

cod. 730/..20030 c/bussola - w/bushing  
cod. 730/..20040 s/bussola - w/o bushing

Rullo abrasivo 50/1  
*Emery feed roll 50/1*



cod. 730/..20090