



PIEDINI CON GUIDA - FEET WITH GUIDE

ADLER

Kl. 67, 167, 267, 69, 169, 269

Kl. 367, 467, 767



I/16-13
67AG2 2mm
67AG3 3mm
67AG4 4mm
67AG5 5mm
67AG6 6mm
67AG7 7mm
67AG8 8mm

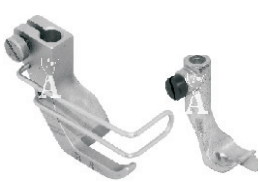

B8
67AG2 2mm
67AG3 3mm
67AG4 4mm
67AG5 5mm
67AG6 6mm
67AG7 7mm
67AG8 8mm

PFAFF / NECCHI

PFAFF Kl. 145, 245, 545, 1245, 335
 NECCHI Kl. 840, 900, 902



91-040475-04/51 - 4,0 mm
91-040475-04/52 - 5,0 mm
91-040475-04/53 - 6,0 mm
91-040475-04/54 - 7,0 mm
91-040475-04/55 - 8,0 mm
91-040475-04/56 - 9,0 mm



67AG2 2mm
67AG3 3mm
67AG4 4mm
67AG5 5mm
67AG6 6mm
67AG7 7mm
67AG8 8mm

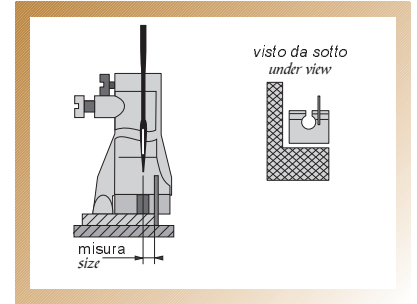

PARTICOLARI PRINCIPALI PER ADLER, PFAFF, NECCHI, JUKI - THE MAIN SPARE PARTS FOR ADLER, PFAFF, NECCHI, JUKI.

ADLER

Kl. 67



067 20075 0
 Placca rasafilo
Thread trimmer needle plate



068 15081 4
 Crochet senza punta
Short gib hook



167 20015 0
 Placca rasafilo - Thread trimmer needle plate



069 00133 0
 Placca ago
Needle plate



069 00581 4
 Crochet - Hook

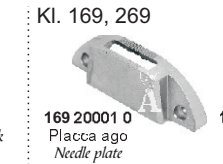

169 20001 0
 Placca ago
Needle plate



169 21008 0 Griffa
Feed dog
169 00181 4 Crochet - Hook



067 21024 0 Griffa foro piccolo
Little hole feed dog
067 21025 0 Griffa foro medio
Medium hole feed dog
067 21028 0 Griffa foro grande
Large hole feed dog

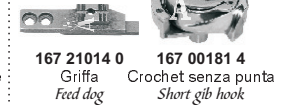

167 21014 0 Griffa
Feed dog
167 00181 4 Crochet senza punta
Short gib hook

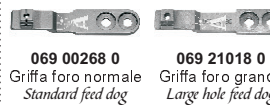

069 00268 0 Griffa foro normale
Standard feed dog
069 21018 0 Griffa foro grande
Large hole feed dog



169 20002 0 Placca ago - stretta
Needle plate - narrow
169 21002 0 Griffa - stretta
Feed dog - narrow

Kl. 169, 269

(Trasformazione per portafogli - Set for wallet)



169 20002 0/P Placca ago
Needle plate
169 21002 0/P Griffa
Feed dog
069 21116 3/P Piedino posteriore
Rear foot
069 22114 3 Piedino anteriore
Front foot

Kl. 367

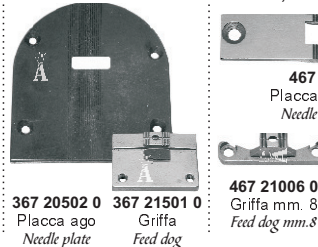

367 20502 0 Placca ago
Needle plate
367 21501 0 Griffa
Feed dog

Kl. 467, 767

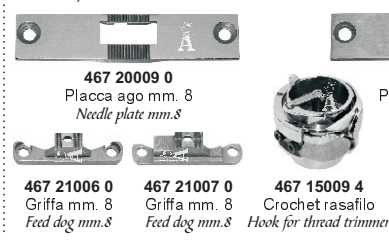

467 20009 0 Placca ago mm. 8
Needle plate mm.8
467 21006 0 Griffa mm. 8
Feed dog mm.8
467 21007 0 Griffa mm. 8
Feed dog mm.8
467 15009 4 Crochet rasafilo
Hook for thread trimmer
467 21004 0 Griffa mm. 6
Feed dog mm.6

Kl. 8967

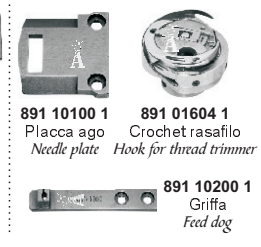

891 10100 1 Placca ago
Needle plate
891 01604 1 Crochet rasafilo
Hook for thread trimmer
891 10200 1 Griffa
Feed dog

PFAFF

Kl. 145, 245



91-026746-04 Placca ago
Needle plate
91-026745-04 Griffa
Feed dog
91-010850-91 Crochet per pelle
Hook for leather

Kl. 545, 1245

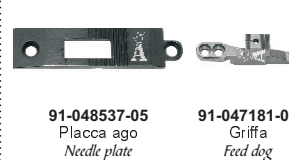

91-048537-05 Placca ago
Needle plate
91-047181-04 Griffa
Feed dog

Kl. 335

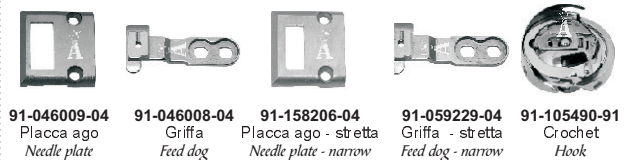

91-046009-04 Placca ago
Needle plate
91-046008-04 Griffa
Feed dog
91-158206-04 Placca ago - stretta
Needle plate - narrow
91-059229-04 Griffa - stretta
Feed dog - narrow
91-105490-91 Crochet
Hook

NECCHI

Kl. 840-130

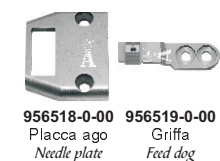

956518-0-00 Placca ago
Needle plate
956519-0-00 Griffa
Feed dog

Kl. 840-100

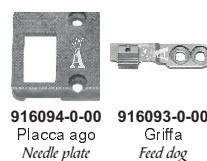

916094-0-00 Placca ago
Needle plate
916093-0-00 Griffa
Feed dog

Kl. 902-155

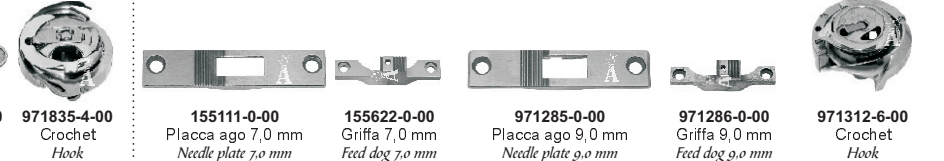

971835-4-00 Crochet
Hook
155111-0-00 Placca ago 7,0 mm
Needle plate 7,0 mm
155622-0-00 Griffa 7,0 mm
Feed dog 7,0 mm
971285-0-00 Placca ago 9,0 mm
Needle plate 9,0 mm
971286-0-00 Griffa 9,0 mm
Feed dog 9,0 mm
971312-6-00 Crochet
Hook

JUKI

Kl. DSC-245

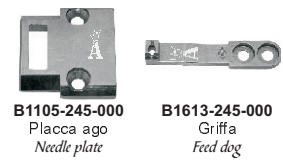

B1105-245-000 Placca ago
Needle plate
B1613-245-000 Griffa
Feed dog

Kl. DSC-246



B1830-245-0A0 Crochet
Hook
211-31206 Placca ago
Needle plate
211-35009 Griffa
Feed dog



Ditta BRUNO ANICHINI

Il più vasto assortimento di ricambi e accessori per macchine da cucire in Italia.
www.brunoanichini.it

The largest stock of spare parts and accessories for sewing machines in Italy.
www.brunoanichini.it