

D

PIEDINI PER TRACOLLE CON ANIMA - FEET FOR SHOULDERS WITH CORD

ADLER

Kl. 67, 167, 267, 69, 169, 269

Posteriore - Rear	Anteriore - Front	misura - size
67E02	67I02	2 mm
67E03	67I03	3 mm
67E04	67I04	4 mm
67E05	67I05	5 mm
67E06	67I06	6 mm
67E07	67I07	7 mm
67E08	67I08	8 mm
67E09	67I09	9 mm
67E10	67I10	10 mm
67E11	67I11	11 mm
67E12	67I12	12 mm

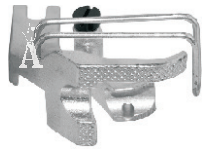

Kl. 367, 467, 767

Posteriore - Rear	Anteriore - Front	misura - size
467E02	67I02	2 mm
467E03	67I03	3 mm
467E04	67I04	4 mm
467E05	67I05	5 mm
467E06	67I06	6 mm
467E07	67I07	7 mm
467E08	67I08	8 mm
467E09	67I09	9 mm
467E10	67I10	10 mm
467E11	67I11	11 mm
467E12	67I12	12 mm

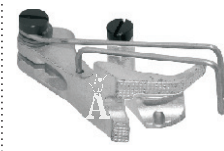

Kl. 8967

Posteriore - Rear	Anteriore - Front	misura - size
8967E02	8967I02	2 mm
8967E03	8967I03	3 mm
8967E04	8967I04	4 mm
8967E05	8967I05	5 mm
8967E06	8967I06	6 mm
8967E07	8967I07	7 mm
8967E08	8967I08	8 mm
8967E09	8967I09	9 mm
8967E10	8967I10	10 mm
8967E11	8967I11	11 mm
8967E12	8967I12	12 mm

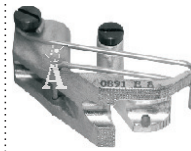

PFAFF / NECCHI

PFAFF Kl. 145, 245, 545, 1245, 335
NECCHI Kl. 840, 900, 902

Posteriore - Rear	Anteriore - Front	misura - size
B/P02	B/A02	2,0 mm
B/P03	B/A03	3,0 mm
B/P04	B/A04	4,0 mm
B/P05	B/A05	5,0 mm
B/P06	B/A06	6,0 mm
B/P07	B/A07	7,0 mm
B/P08	B/A08	8,0 mm
B/P09	B/A09	9,0 mm
B/P10	B/A10	10,0 mm
B/P11	B/A11	11,0 mm
B/P12	B/A12	12,0 mm

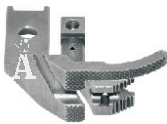

PFAFF Kl. 145, 245, 545, 1245, 335
NECCHI Kl. 840, 900, 902

Per materiali delicati - For thin materials

Posteriore - Rear	Anteriore - Front	misura - size
A/P02	A/A02	2,0 mm
A/P03	A/A03	3,0 mm
A/P04	A/A04	4,0 mm
A/P05	A/A05	5,0 mm
A/P06	A/A06	6,0 mm
A/P07	A/A07	7,0 mm
A/P08	A/A08	8,0 mm
A/P09	A/A09	9,0 mm
A/P10	A/A10	10,0 mm
A/P11	A/A11	11,0 mm
A/P12	A/A12	12,0 mm

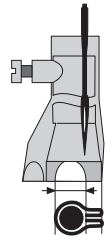
visto da sotto
under view

Per una tracolla corretta si consiglia di utilizzare piedini di misura corrispondente alla tracolla da eseguire.
For an accurate shoulder is recommendable to use right size feet in accordance with work to be made.

E

PIEDINI PER FILETTO - PIPING FEET

ADLER

Kl. 67, 167, 267

Intero Whole

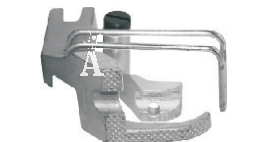

Posteriore - Rear	Anteriore - Front	misura - size
067 22145 3	067 22144 3	2 mm
067 22074 3	067 22066 3	3 mm
067 22075 3	067 22067 3	4 mm
067 22076 3	067 22068 3	5 mm
067 22077 3	067 22069 3	6 mm
067 22127 3	067 22125 3	7 mm
067 22128 3	067 22126 3	8 mm

Kl. 69, 169, 269

Mezzo Half

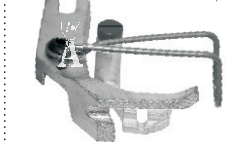

Posteriore - Rear	Anteriore - Front	misura - size
69ZP/3,5	69ZA/3,5	3,5 mm
69ZP/4,0	69ZA/4,0	4,0 mm
69ZP/4,5	69ZA/4,5	4,5 mm
69ZP/5,0	69ZA/5,0	5,0 mm
69ZP/6,0	69ZA/6,0	6,0 mm
69ZP/7,0	69ZA/7,0	7,0 mm
69ZP/8,0	69ZA/8,0	8,0 mm

Kl. 367, 467, 767

Intero Whole

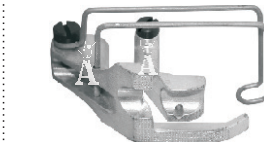

Posteriore - Rear	Anteriore - Front	misura - size
367 22031 3	067 22066 3	3 mm
367 22011 3	067 22067 3	4 mm
367 22012 3	067 22068 3	5 mm
367 22013 3	067 22069 3	6 mm
367 22032 3	067 22125 3	7 mm
367 22033 3	067 22126 3	8 mm
367 90008 8	067 90011 7	9 mm
367 90008 9	067 90010 8	10 mm
367 90010 9	067 90024 2	12 mm

Kl. 367, 467, 767

Mezzo Half

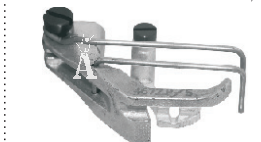

Posteriore - Rear	Anteriore - Front	misura - size
467ZP/3,5	69ZA/3,5	3,5 mm
467ZP/4,0	69ZA/4,0	4,0 mm
467ZP/4,5	69ZA/4,5	4,5 mm
467ZP/5,0	69ZA/5,0	5,0 mm
467ZP/6,0	69ZA/6,0	6,0 mm
467ZP/7,0	69ZA/7,0	7,0 mm
467ZP/8,0	69ZA/8,0	8,0 mm
467ZP/9,0	69ZA/9,0	9,0 mm
467ZP/10,0	69ZA/10,0	10,0 mm
467ZP/12,0	69ZA/12,0	12,0 mm

Kl. 8967

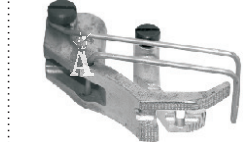

Posteriore - Rear	Anteriore - Front	misura - size
8967ZP/3,5	8967ZA/3,5	3,5 mm
8967ZP/4,0	8967ZA/4,0	4,0 mm
8967ZP/4,5	8967ZA/4,5	4,5 mm
8967ZP/5,0	8967ZA/5,0	5,0 mm
8967ZP/6,0	8967ZA/6,0	6,0 mm
8967ZP/7,0	8967ZA/7,0	7,0 mm
8967ZP/8,0	8967ZA/8,0	8,0 mm

Piedini posteriore vers. PAS
Rear feet PAS' version

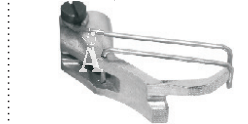

8967PA S3,5	3,5 mm
8967PA S4,0	4,0 mm
8967PA S4,5	4,5 mm
8967PA S5,0	5,0 mm
8967PA S6,0	6,0 mm
8967PA S7,0	7,0 mm
8967PA S8,0	8,0 mm

PFAFF / NECCHI

PFAFF Kl. 145, 245, 545, 1245, 335
NECCHI Kl. 840, 900, 902



Posteriore - Rear	Anteriore - Front	misura - size
91-042443-04/54	91-042442-93/53	3,5 mm
91-042443-04/55	91-042442-93/54	4,0 mm
91-042443-04/56	91-042442-93/55	4,5 mm
91-042443-04/57	91-042442-93/56	5,0 mm
91-042443-04/59	91-042442-93/58	6,0 mm
91-042443-04/61	91-042442-93/60	7,0 mm
91-042443-04/63	91-042442-93/61	8,0 mm

PFAFF Kl. 145, 245, 545, 1245, 335
NECCHI Kl. 840, 900, 902



Piedini versione PAS - Feet PAS' version	misura - size
91-046719-04/53	3,0 mm
91-046719-04/55	4,0 mm
91-046719-04/57	5,0 mm
91-046719-04/59	6,0 mm
91-046719-04/61	7,0 mm
91-046720-93/53	3,0 mm
91-046720-93/55	4,0 mm
91-046720-93/57	5,0 mm
91-046720-93/59	6,0 mm
91-046720-93/60	7,0 mm

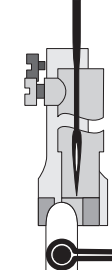

visto da sotto
under view

Per un filetto corretto si consiglia di utilizzare piedini di misura corrispondente al filetto da eseguire.
For an accurate piping is recommendable to use right size feet in accordance with work to be made.