

ORLATORI
BORDATORI
GUIDE COLLARETTO
RIBATTITORI
ACCOPIATORI
GUIDE PROFILO
GUIDE PASSAELASTICO
GUIDE VARIE
ATTACCHI
FRENAGGI



Ditta B. ANICHINI S.r.l.

Via A. Corelli, 67,69,71 - 50127 FIRENZE (ITALIA)

TEL. 055/419845 (R.A) - FAX 055/4379249

internet: www.brunoanichini.it

E.MAIL: brunoanichini@tin.it



F75U ORLATORE PIEGA SUPERIORE

Per macchine piane
For flat bed machines

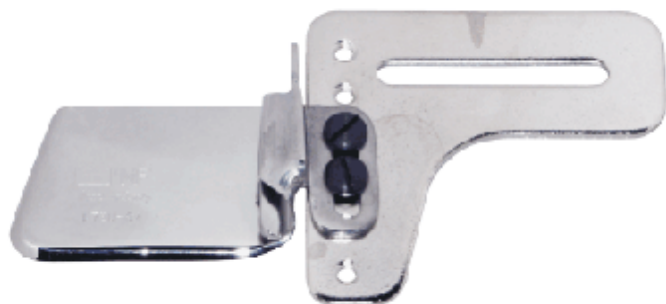

PIEDINI CONSIGLIATI
SUGGESTED FEET



G2450A - fino a 12 mm
G2460A - da 13 a 25 mm
G2470A - oltre 25 mm

NOTA:
da 10 mm in su a richiesta
fornibili con passaggio "H"

NOTE:
for over 10 mm available on
request with "H" passage

SINGLE UPTURN HEMMER

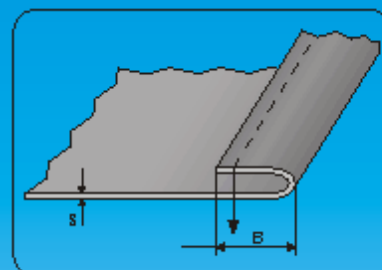

Codice	Lav. finito (B) (fl & led s/be) (mm)	Spessore (S) (thickness) (mm)	
F75U/4M	4 5/32	M	
F75U/5M	5 3/16	M	
F75U/6M	6 1/4	M	
F75U/7M	7 9/32	M	
F75U/8M	8 5/16	M	
F75U/9M	9 11/32	M	
F75U/10M	10 3/8	M	
F75U/10H	10 3/8	H	
F75U/12M	12 1/2	M	
F75U/15M	15 19/32	M	
F75U/20M	20 3/4	M	
F75U/25M	25 1	M	
F75U/30M	30 1-3/16	M	
F75U/35M	35 1-3/8	M	
F75U/40M	40 1-9/16	M	
F75U/45M	45 1-3/4	M	
F75U/50M	50 2	M	
F75U/60M	60 2-3/8	M	

F75UGA ORLATORE PIEGA SUPERIORE CON GUIDA APRIBILE

Per macchine piane
For flat bed machines



PIEDINI CONSIGLIATI
SUGGESTED FEET



G2450A - fino a 12 mm
G2460A - da 13 a 25 mm
G2470A - oltre 25 mm

NOTA:
da 10 mm in su a richiesta
fornibili con passaggio "H"

NOTE:
for over 10 mm available on
request with "H" passage

SINGLE UPTURN SWING HEMMER

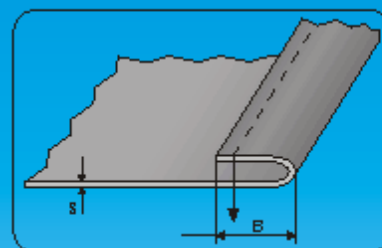

Codice	Lav. finito (B) (fl & led s/be) (mm)	Spessore (S) (thickness) (mm)	
F75UGA/4M	4 5/32	M	
F75UGA/5M	5 3/16	M	
F75UGA/6M	6 1/4	M	
F75UGA/7M	7 9/32	M	
F75UGA/8M	8 5/16	M	
F75UGA/9M	9 11/32	M	
F75UGA/10M	10 3/8	M	
F75UGA/12M	12 1/2	M	
F75UGA/14M	14 9/16	M	
F75UGA/15M	15 19/32	M	
F75UGA/16M	16 5/8	M	
F75UGA/20M	20 3/4	M	
F75UGA/25M	25 1	M	
F75UGA/30M	30 1-3/16	M	
F75UGA/35M	35 1-3/8	M	
F75UGA/40M	40 1-9/16	M	
F75UGA/45M	45 1-3/4	M	
F75UGA/50M	50 2	M	
F75UGA/60M	60 2-3/8	M	

F19 ORLATORE - PIEGA SUPERIORE CON INSERIMENTO CORDINO

Per macchine piano 1 ago
For 1 needle flat bed machines

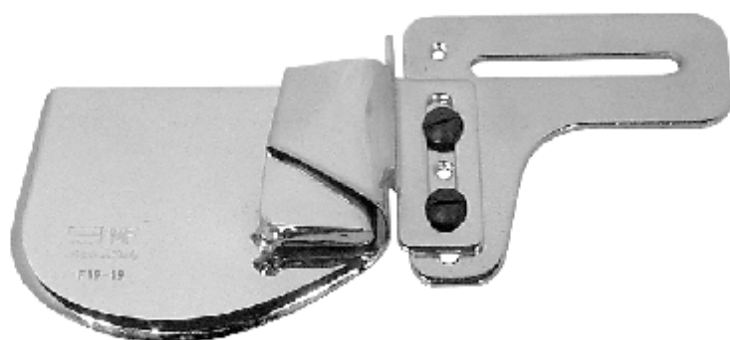

SINGLE UPTURN CORD FOLDER

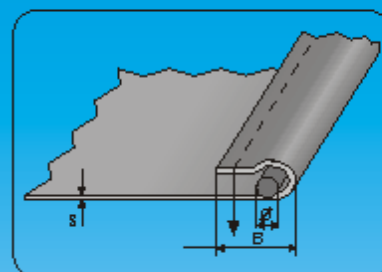

Codice	Lav. finito (B) (fin. bed size) (mm) (in)	Spessore (S) (thickness) (mm)	Ø cordino Ø cord (mm)
F19/7M	7 9/32	M	max 2,5
F19/10M	10 3/8	M	max 3,0
F19/16M	16 5/8	M	max 5,0
F19/19M	19 3/4	M	max 6,0

NOTA:
con l'ordinazione specificare Ø cordino

NOTE:
with order specify Ø cord

F21 ORLATORE PIEGA SUPERIORE CON INSERIMENTO CORDINO

Per macchine piano 1 o 2 aghi
For 1 or 2 needle flat bed machines

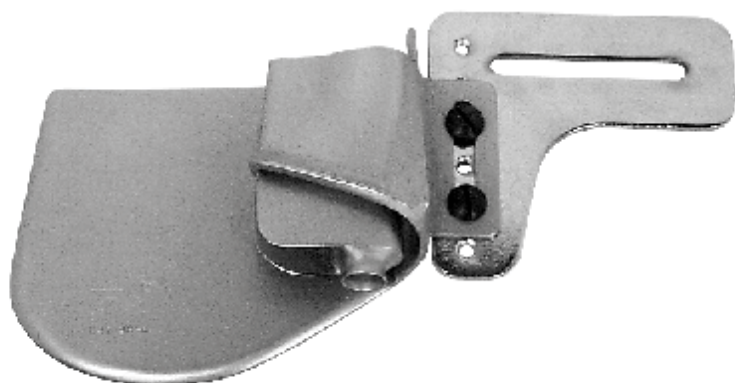

SINGLE UPTURN CORD FOLDER

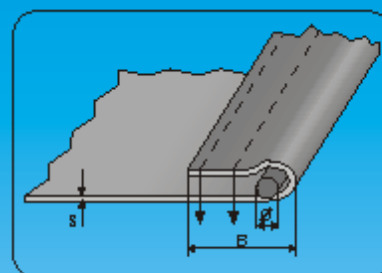

Codice	Lav. finito (B) (fin. bed size) (mm) (in)	Spessore (S) (thickness) (mm)	Ø cordino Ø cord (mm)
F21/25M	25 1	M	max 8,0
F21/30M	30 1-3/16	M	max 8,0
F21/35M	35 1-3/8	M	max 8,0

NOTA:
con l'ordinazione specificare Ø cordino

NOTE:
with order specify Ø cord

F1086 ORLATORE PIEGA INFERIORE PER MAGLIERIA A CAPO APERTO

Per macchine piane 2 aghi
For 2 needle flat bed machines

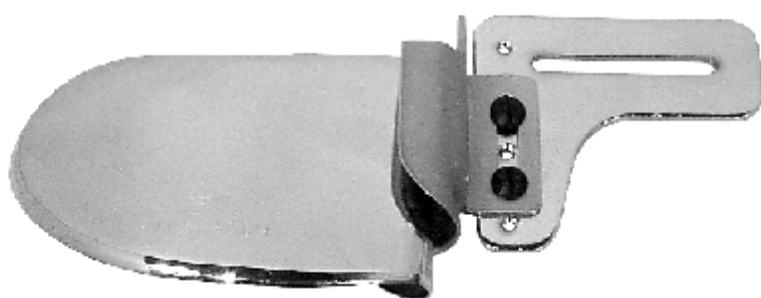

*SINGLE DOWNTURN HEMMER
FOR KNITTED FABRIC*

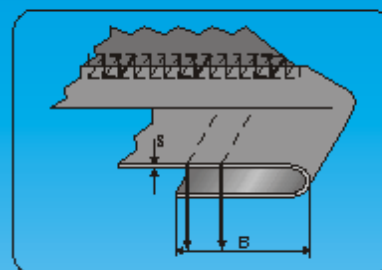

Codice	Lav. finito (B) (finished size) (mm) (inch)	Spessore (S) (thickness)	
F1086/15M	15 19/32	M	
F1086/15H	15 19/32	H	
F1086/20M	20 3/4	M	
F1086/20H	20 3/4	H	
F1086/25M	25 1	M	
F1086/25H	25 1	H	
F1086/30M	30 1-3/16	M	
F1086/30H	30 1-3/16	H	
F1086/35M	35 1-3/8	M	
F1086/35H	35 1-3/8	H	
F1086/40M	40 1-9/16	M	
F1086/40H	40 1-9/16	H	

F1087 ORLATORE PIEGA INFERIORE PER MAGLIERIA

Per macchine piane 2 aghi
For 2 needle flat bed machines

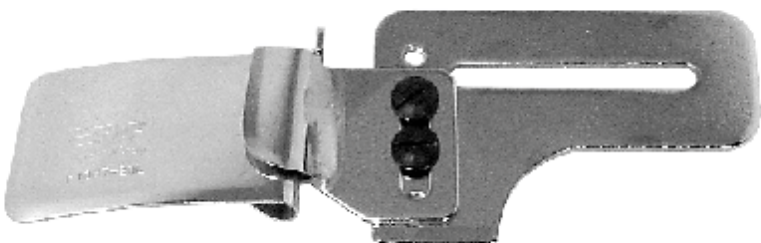

*ADJUSTABLE DOWNTURN HEMMER
FOR KNITTED FABRIC*

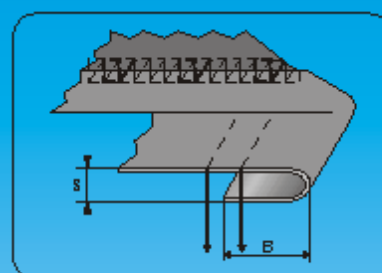

Codice	Lav. finito (B) (finished size) (mm) (inch)	Spessore (S) (thickness)	
F1087/8M	8 5/16	M	
F1087/8H	8 5/16	H	
F1087/10M	10 3/8	M	
F1087/10H	10 3/8	H	
F1087/15M	15 19/32	M	
F1087/15H	15 19/32	H	
F1087/20L	20 3/4	L	
F1087/20M	20 3/4	M	
F1087/20H	20 3/4	H	
F1087/25M	25 1	M	
F1087/25H	25 1	H	
F1087/30M	30 1-3/16	M	
F1087/30H	30 1-3/16	H	

F72L ORLATORE DOPPIA PIEGA SUPERIORE CON GUIDA APRIBILE

Per macchine piane
For flat bed machines

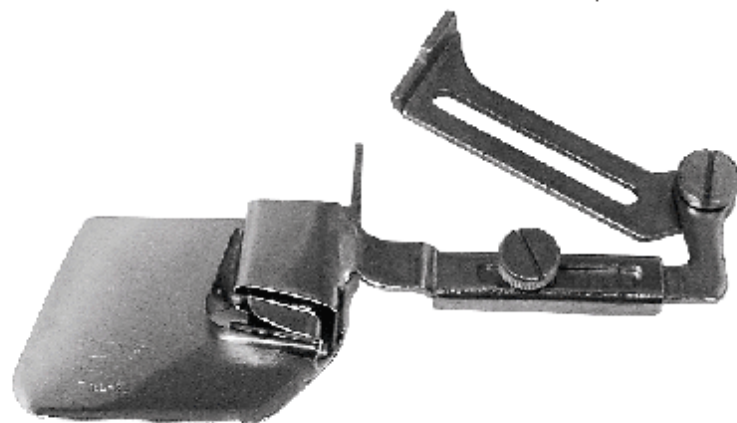

PIEDINI CONSIGLIATI
SUGGESTED FEET



G2450A - fino a 12 mm
G2460A - da 13 a 25 mm
G2470A - oltre 25 mm

DOUBLE UPTURN SWING HEMMER

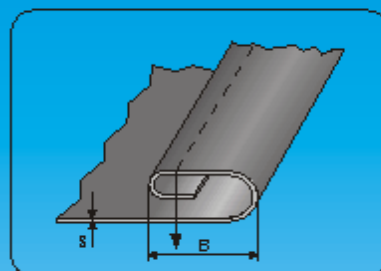

Codice	Lav. finito (B) (fin. led size) (mm) (in)		
F72L/4	4 5/32		
F72L/5	5 3/16		
F72L/6	6 1/4		
F72L/7	7 9/32		
F72L/8	8 5/16		
F72L/9	9 11/32		
F72L/10	10 3/8		
F72L/12	12 1/2		
F72L/14	14 9/16		
F72L/15	15 19/32		
F72L/16	16 5/8		
F72L/19	19 3/4		
F72L/20	20 25/32		
F72L/22	22 7/8		
F72L/25	25 1		
F72L/28	28 1-1/8		

F72B ORLATORE DOPPIA PIEGA SUPERIORE REGISTRABILE - CON GUIDA APRIBILE

Per macchine piane
For flat bed machines



PIEDINI CONSIGLIATI
SUGGESTED FEET



G2450A - fino a 12 mm
G2460A - da 13 a 25 mm
G2470A - oltre 25 mm

STAFFA CONSIGLIATA
SUGGESTED BRACKET



PER MISURE DA 30 mm IN SU
/FROM 3/4" TO 1 1/8" IN

DOUBLE UPTURN SWING HEMMER

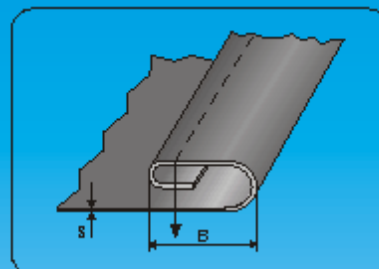

Codice	Lav. finito (B) (fin. led size) (mm) (in)	Codice	Lav. finito (B) (fin. led size) (mm) (in)
F72B/4	4 5/32	F72B/30	30 1-3/16
F72B/5	5 3/16	F72B/32	32 1-1/4
F72B/6	6 1/4	F72B/35	35 1-3/8
F72B/7	7 9/32	F72B/38	38 1-1/2
F72B/8	8 5/16	F72B/40	40 1-9/16
F72B/9	9 11/32	F72B/45	45 1-3/4
F72B/10	10 3/8	F72B/50	50 2
F72B/12	12 1/2	F72B/55	55 2-3/16
F72B/14	14 9/16	F72B/60	60 2-3/8
F72B/15	15 19/32	F72B/70	70 2-3/4
F72B/16	16 5/8	F72B/76	76 3-1/32
F72B/19	19 3/4	F72B/80	80 3-3/16
F72B/20	20 25/32	F72B/88	88 3-1/2
F72B/22	22 7/8	F72B/100	100 4
F72B/25	25 1	F72B/127	127 5
F72B/28	28 1-1/8		

F105 ORLATORE DOPPIA PIEGA SUP. PER TASCHE CURVE E DRITTE

Per macchine piane
For flat bed machines

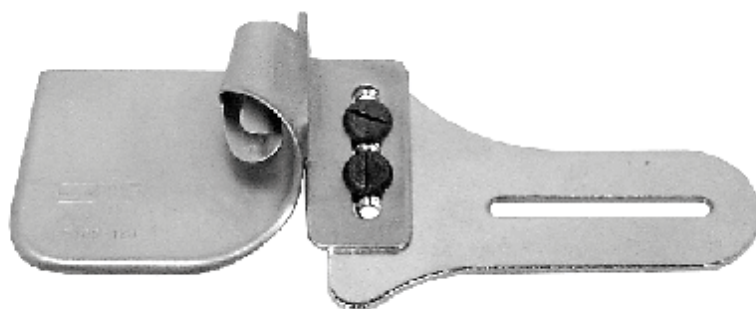

PIEDINI CONSIGLIATI
SUGGESTED FEET



G2450A - fino a 12 mm
G2460A - da 13 a 25 mm

DOUBLE UFTURN HEMMER
FOR CURVED AND STRAIGHT POCKETS

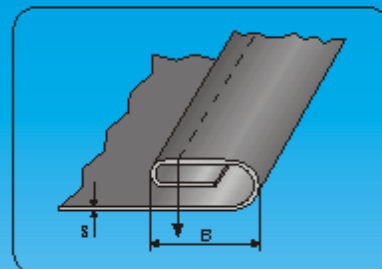

Codice	Lav. finito (B) (finished size) (mm) (inch)	Spessore (S) (thickness)	
F 105/4M	4 5/32	M	
F 105/5M	5 3/16	M	
F 105/6M	6 1/4	M	
F 105/7M	7 9/32	M	
F 105/8M	8 5/16	M	
F 105/8H	8 5/16	H	
F 105/9M	9 11/32	M	
F 105/10M	10 3/8	M	
F 105/10H	10 3/8	H	
F 105/12M	12 1/2	M	
F 105/12H	12 1/2	H	
F 105/14M	14 9/16	M	
F 105/15M	15 19/32	M	
F 105/16M	16 5/8	M	
F 105/18M	18 23/32	M	

F105GA ORLATORE DOPPIA PIEGA SUP. GUIDA APRIBILE PER TASCHE CURVE E DRITTE

Per macchine piane
For flat bed machines

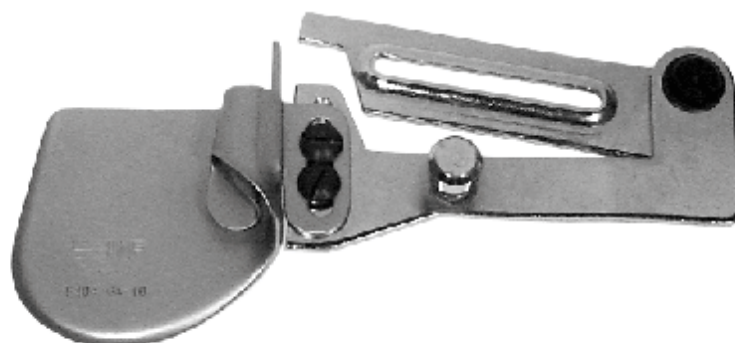

PIEDINI CONSIGLIATI
SUGGESTED FEET



G2450A - fino a 12 mm
G2460A - da 13 a 25 mm

DOUBLE UFTURN HEMMER
FOR CURVED AND STRAIGHT POCKETS

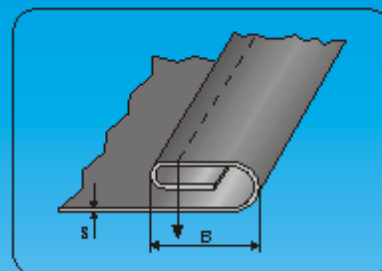

Codice	Lav. finito (B) (finished size) (mm) (inch)	Spessore (S) (thickness)	
F 105GA/4M	4 5/32	M	
F 105GA/5M	5 3/16	M	
F 105GA/6M	6 1/4	M	
F 105GA/7M	7 9/32	M	
F 105GA/8M	8 5/16	M	
F 105GA/9M	9 11/32	M	
F 105GA/10M	10 3/8	M	
F 105GA/12M	12 1/2	M	
F 105GA/14M	14 9/16	M	
F 105GA/15M	15 19/32	M	
F 105GA/16M	16 5/8	M	
F 105GA/18M	18 23/32	M	

F450 ORLATORE DOPPIA PIEGA SUPERIORE CON MOLLA

*Per macchine piane
For flat bed machines*

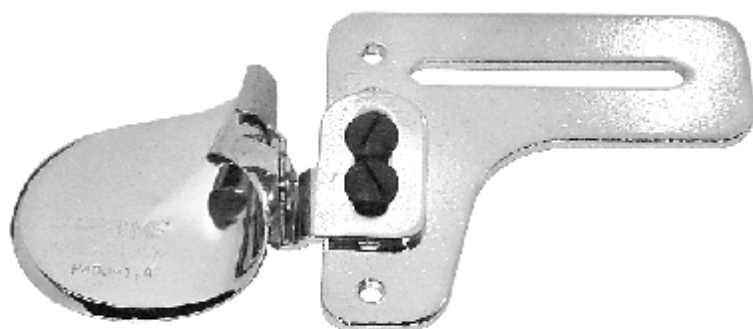

MOLLA DI RICAMBIO
SPARE SPRING



PIEDINI CONSIGLIATI
SUGGESTED FEET



G13009-1/16 fino a 1,6 mm
G13009-1/8 da 1,6 a 3,2 mm
G13009-3/16 da 3,2 a 4,8 mm
G13009-1/4 da 4,8 a 6,4 mm
G13009-3/8 da 6,4 a 9,5 mm

F450M/1,6 - molla mm 1,6 (spring 1,6 mm)
F450M/2,0 - molla mm 2,0 (spring 2,0 mm)
F450M/3,2 - molla mm 3,2 (spring 3,2 mm)
F450M/4,8 - molla mm 4,8 (spring 4,8 mm)
F450M/6,4 - molla mm 6,4 (spring 6,4 mm)
F450M/9,5 - molla mm 9,5 (spring 9,5 mm)

DOUBLE UPTURN SPRING HEMMER

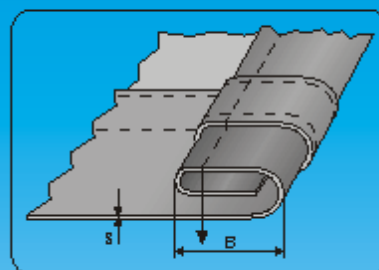

Codice	Lav. finito (B) (ft. finished size) (in) (out)	Spessore (S) (ft. thickness)	
F450/2,0	2,0 5/84	M	
F450/3,2	3,2 1/8	M	
F450/4,8	4,8 3/16	M	
F450/6,4	6,4 1/4	M	
F450/9,5	9,5 3/8	M	

F70 ORLATORE A MOLLA - DOPPIA PIEGA SUPERIORE CON GUIDA APRIBILE

*Per macchine piane
For flat bed machines*

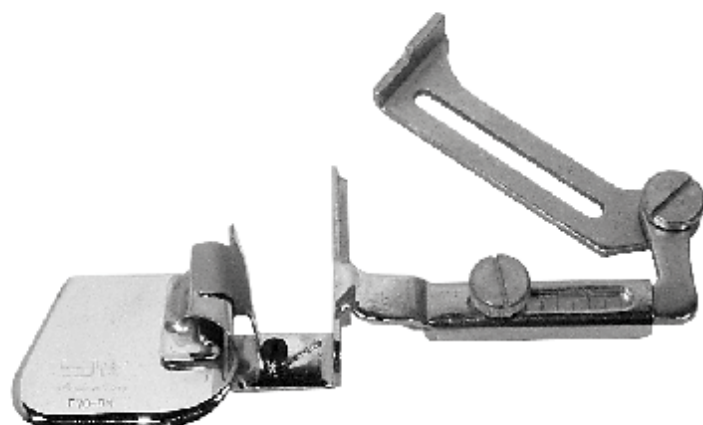

PIEDINI CONSIGLIATI
SUGGESTED FEET



G13009-1/16 fino a 1,6 mm
G13009-1/8 da 1,6 a 3,2 mm
G13009-3/16 da 3,2 a 4,8 mm
G13009-1/4 da 4,8 a 6,4 mm
G13009-3/8 da 6,4 a 9,5 mm

DOUBLE UPTURN SPRING HEMMER

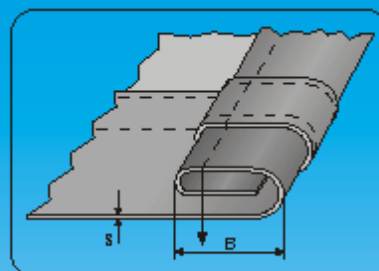

Codice	Lav. finito (B) (ft. finished size) (in) (out)	Spessore (S) (ft. thickness)	
F70/2,0L	2,0 5/84	L	
F70/3,2L	3,2 1/8	L	
F70/4,8L	4,8 3/16	L	
F70/4,8M	4,8 3/16	M	
F70/6,4L	6,4 1/4	L	
F70/6,4M	6,4 1/4	M	
F70/8,0L	8,0 5/16	L	
F70/8,0M	8,0 5/16	M	
F70/9,5L	9,5 3/8	L	
F70/9,5M	9,5 3/8	M	
F70/12,7L	12,7 1/2	L	
F70/12,7M	12,7 1/2	M	
F70/14M	14 9/16	M	
F70/16M	16 5/8	M	
F70/19M	19 3/4	M	

F175 ORLATORE DOPPIA PIEGA SUPERIORE CON INSERIMENTO CORDINO IN PIOMBO

Per macchine piane
For flat bed machines

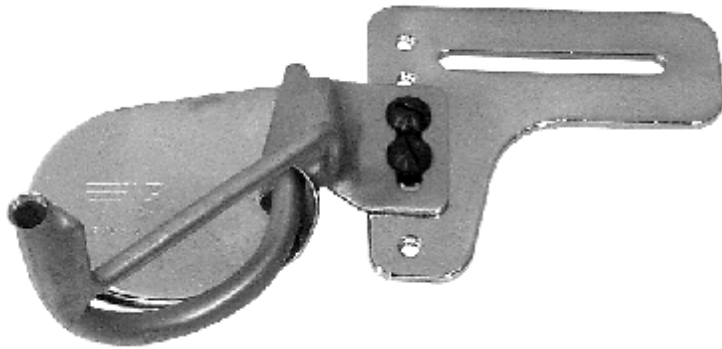

DOUBLE UPTURN HEMMER

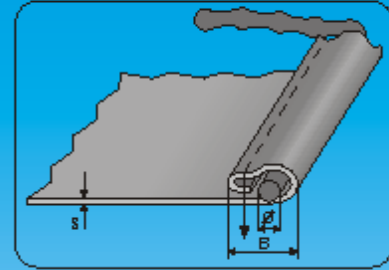

Codice	Lav. finito (B) (ft. finished size) (in) (inch)	Spessore (S) (ft. thickness)	Ø cordino (Ø cord) (mm)
F 175/8M	8 5/16	M	3,0
F 175/10M	10 3/8	M	3,0
F 175/12M	12 1/2	M	3,0

PIEDINO CONSIGLIATO
SUGGESTED FOOT



G36069HR-1/8

F74 ORLATORE DOPPIA PIEGA SUPERIORE CON INSERIMENTO CORDINO

Per macchine piane
For flat bed machines

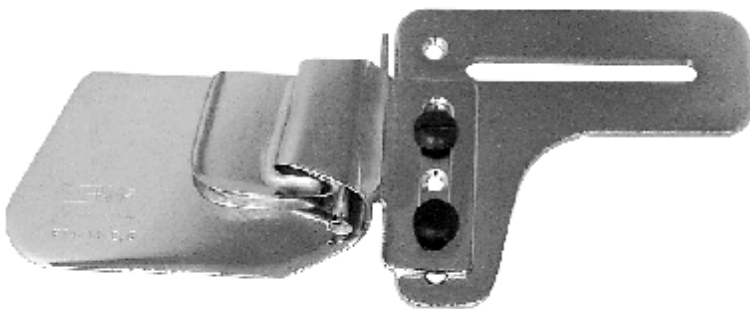

DOUBLE UPTURN CORD HEMMER

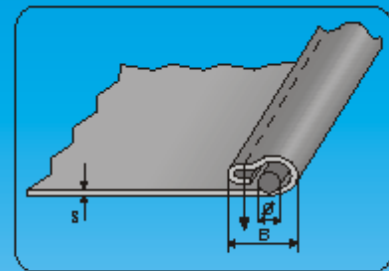

Codice	Lav. finito (B) (ft. finished size) (in) (inch)	Spessore (S) (ft. thickness)	Ø cordino (Ø cord) (mm)
F74/6M	6 1/4	M	max 2,5
F74/8M	8 5/16	M	max 3,0
F74/10M	10 3/8	M	max 3,0
F74/12M	12 1/2	M	max 4,0
F74/14M	14 9/16	M	max 4,0
F74/16M	16 5/8	M	max 5,0
F74/18M	18 3/4	M	max 5,0

NOTA:
con l'ordinazione specificare diametro cordino

NOTE
with order specify diameter of the cord

F174 ORLATORE DOPPIA PIEGA SUPERIORE CON INSERIMENTO CORDINO

Per macchine piane a 1 o 2 aghi
For 1 or 2 needle flat bed machines



DOUBLE UPTURN CORD HEMMER

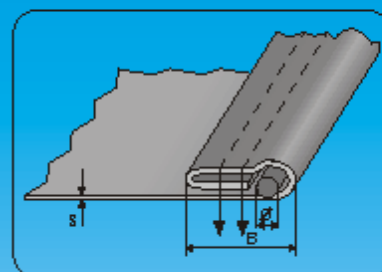

Codice	Lav. finito (B) (finished size) (mm) (inch)	Spessore (S) (thickness) (mm)	Ø cordino (cord dia.) (mm)
F 174/18M	18 3/4	M	max 8,0
F 174/20M	20 25/32	M	max 8,0
F 174/25M	25 1	M	max 8,0
F 174/30M	30 1-3/16	M	max 8,0

NOTA:
con l'ordinazione specificare diametro cordino

NOTE:
with order specify diameter of the cord

F1174 ORLATORE DOPPIA PIEGA SUPERIORE CON INS. CORDINO PER TENDE DA ESTERNO

Per macchine piane a 1 o 2 aghi
For 1 or 2 needle flat bed machines



*DOUBLE UPTURN CORD HEMMER
FOR OUTSIDE CURTAIN*

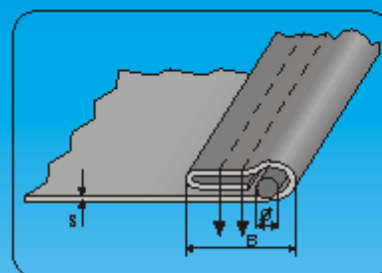

Codice	Lav. finito (B) (finished size) (mm) (inch)	Spessore (S) (thickness) (mm)	Ø cordino (cord dia.) (mm)
F1174/18M	18 3/4	MH	max 8,0
F1174/20M	20 25/32	MH	max 8,0
F1174/25M	25 1	MH	max 8,0
F1174/30M	30 1-3/16	MH	max 8,0

NOTA:
con l'ordinazione specificare diametro cordino

NOTE:
with order specify diameter of the cord

F815 ORLATORE DOPPIO REGOLABILE, PIEGA INFERIORE CON INSERIMENTO CERNIERA

Per macchine piane 2 aghi
For 2 needle flat bed machines

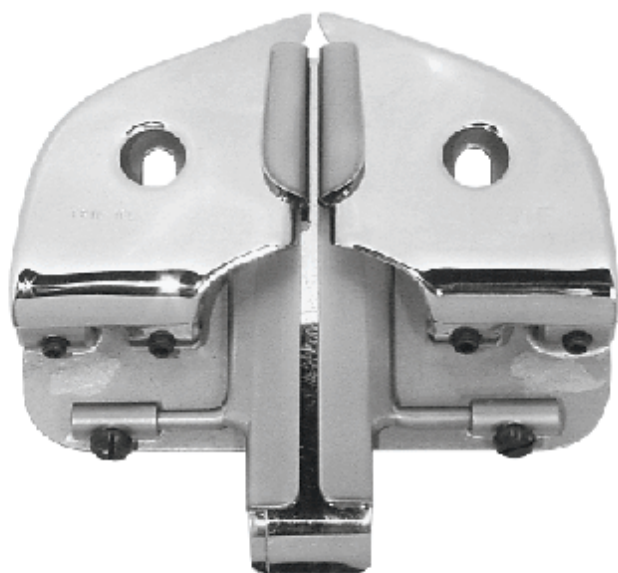

***DOUBLE ADJUSTABLE HEMMER
WITH ZIP INSERTION***

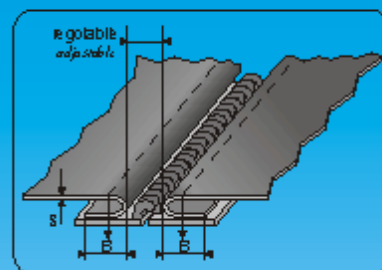

Codice	Lav. finito (B) (fin. bed size) (mm) (inch)	Spessore (S) (thickness) (mm)	Cerniera (zip) (mm)
F815	10 25/64	M	regolabile

F172 ORLATORE PER LENZUOLA CON INSERIMENTO PROFILO PREFABBRICATO

Per macchine piane
For flat bed machines

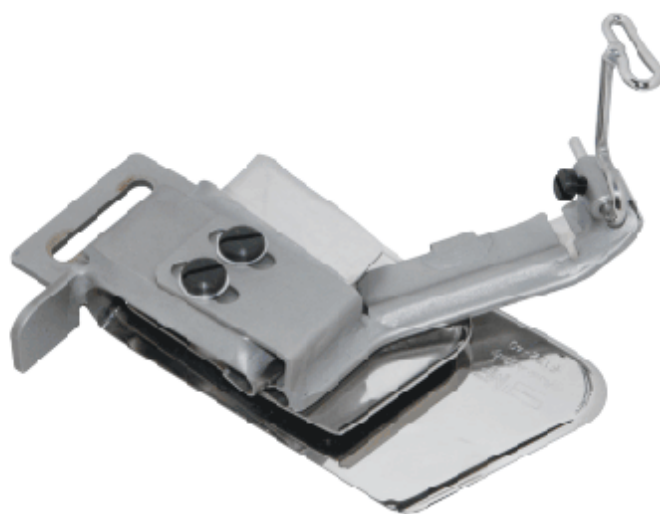

***HEMMER FOR SHEETS WITH
READY-MADE PIPING INSERTION***

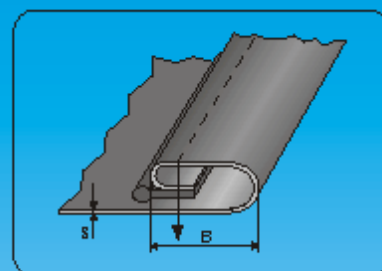

Codice	Entrata (A) (tape size) (mm)	Lav. finito (B) (fin. bed size) (mm)	Spessore (S) (thickness) (mm)

L' APPARECCHIO VIENE FORNITO SU RICHIESTA

Con l'ordinazione è necessario che ci siano inviati sia il campione di materiale che deve essere utilizzato, sia il campione del profilo prefabbricato che deve essere inserito.

MANUFACTURED ON REQUEST

With the order we need to receive both sample of material to be used and sample of ready-made piping to be inserted.

STAFFA A CORREDO
EQUIPPED WITH BRACKET CPL



F1106

F1125 ORLATORE DOPPIA PIEGA INFERIORE

Per macchine piane
For flat bed machines

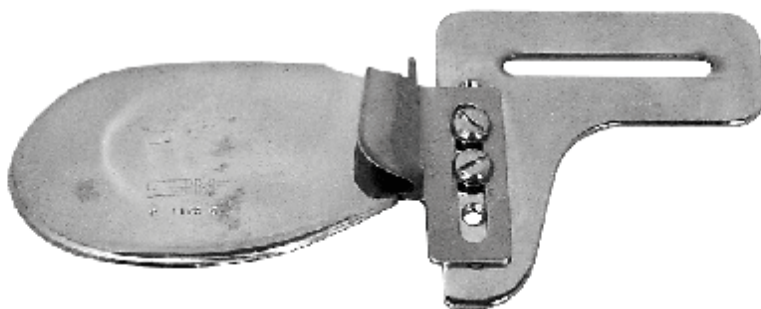

PIEDINO CONSIGLIATO
SUGGESTED FOOT



G2450A - per tutte le misure
(for all sizes)

DOUBLE DOWNTURN HEMMER

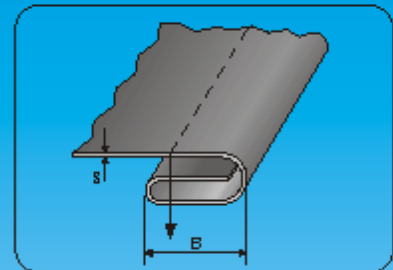

Codice	Lav. finito (B) (finished size) (mm)	Codice	Lav. finito (B) (finished size) (mm)
F 1125/5M	5M	F 1125/14MH	14MH
F 1125/6M	6M	F 1125/14H	14H
F 1125/6MH	6MH		
F 1125/7M	7M		
F 1125/7MH	7MH		
F 1125/8M	8M		
F 1125/8MH	8MH		
F 1125/8H	8H		
F 1125/9MH	9MH		
F 1125/10L	10L		
F 1125/10M	10M		
F 1125/10MH	10MH		
F 1125/10H	10H		
F 1125/12MH	12MH		
F 1125/12H	12H		

F1125GA ORLATORE DOPPIA PIEGA INFERIORE CON GUIDA APRIBILE

Per macchine piane
For flat bed machines

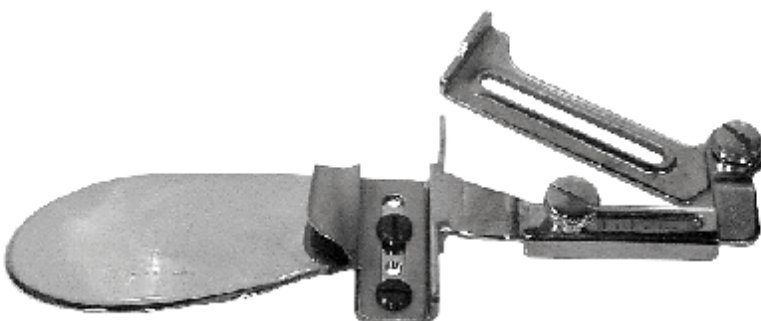

PIEDINO CONSIGLIATO
SUGGESTED FOOT



G2450A - per tutte le misure
(for all sizes)

DOUBLE DOWNTURN SWING HEMMER

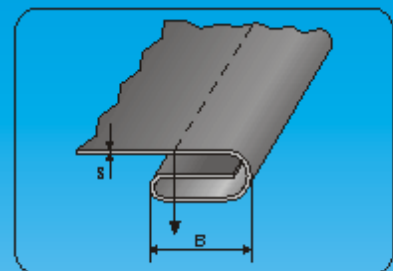

Codice	Lav. finito (B) (finished size) (mm)	Spessore (S) (thickness)	
F 1125GA/5M	5	3/16	M
F 1125GA/6M	6	1/4	M
F 1125GA/7M	7	9/32	M
F 1125GA/8M	8	5/16	M
F 1125GA/9MH	9	11/32	MH
F 1125GA/10M	10	3/8	M
F 1125GA/10MH	10	3/8	MH
F 1125GA/12MH	12	1/2	MH
F 1125GA/14MH	14	9/16	MH

F1120 ORLATORE DOPPIA PIEGA INFERIORE PER TASCHE CURVE E DRITTE

Per macchine piane
For flat bed machines

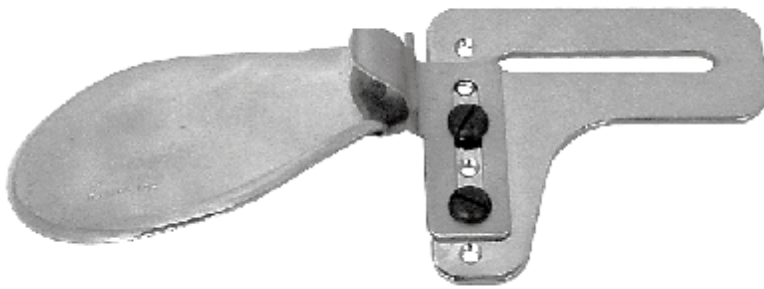

PIEDINO CONSIGLIATO
SUGGESTED FOOT



G2450A - per tutte le misure
(for all sizes)

DOUBLE DOWNTURN HEMMER
FOR CURVED AND STRAIGHT POCKETS

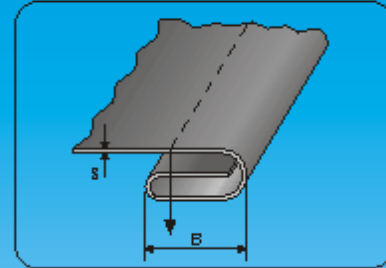

Codice	Lav. finito (B)		Spessore (S)
	(in inched size)	(in cm)	
F 1120/8H	8	5/16	H
F 1120/10H	10	3/8	H
F 1120/12H	12	1/2	H

F180 ORLATORE PER TASCHE DRITTE

Per macchine piane
For flat bed machines



DOWNTURN HEMMER FOR
JEANS PATCH-POKETS

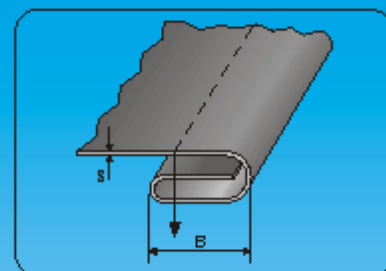

Codice	Lav. finito (B)		Spessore (S)
	(in inched size)	(in cm)	
F180/12M	12	1/2	M
F180/12H	12	1/2	H

STAFFA A CORREDO
EQUIPPED WITH BRACKET CPL



F1106

F95 ORLATORE PER CANOLO CAMICIA CON INSERIMENTO DEL RINFORZO

Per macchine piane 2 aghi
For 2 needle flat bed machines

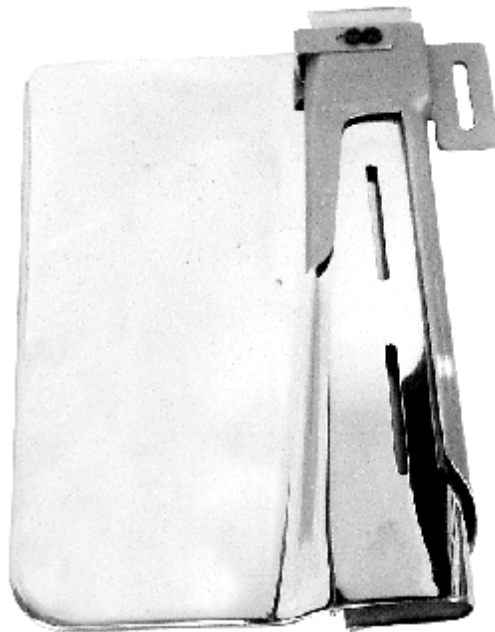

*BUTTON STAY HEMMER
WITH TAPE INSERTION*

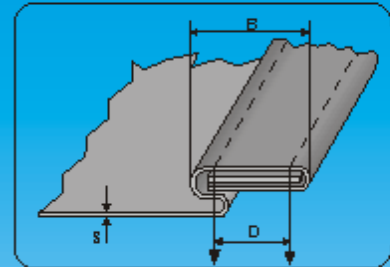

Codice	Lav. finito (B) (finished size) (mm) (inch)	Dist. aghi (D) (needle gauge) (mm) (inch)	Spessore (S) (thickness)
F95/25M	25 1	16 5/8	M
F95/30M	30 1-3/16	20 25/32	M
F95/35M	35 1-3/8	24 15/16	M
F95/37M	37 1-	25 1	M

NOTA:
A richiesta fornibili con passaggio "L"
NOTE:
Available on request with "L" passage.

STAFFA A CORREDO
EQUIPPED WITH BRACKET CPL.

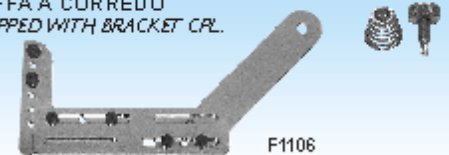

F1106

F77 ORLATORE DOPPIA PIEGA SUPERIORE PER CANOLO CAMICIA

Per macchine piane
For flat bed machines

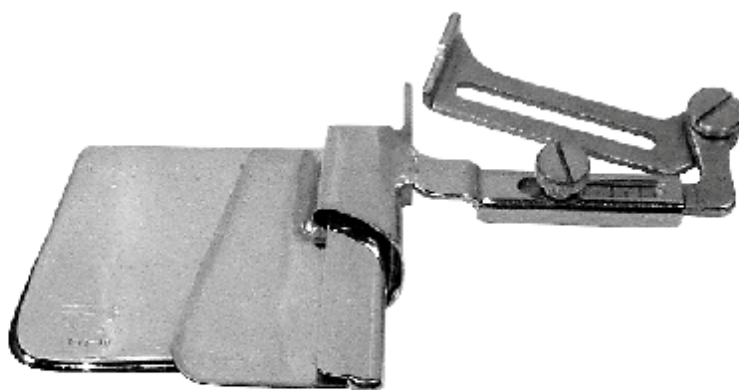

BUTTON STAY HEMMER

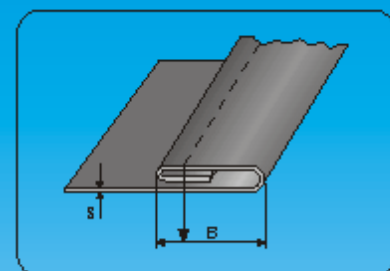

Codice	Lav. finito (B) (finished size) (mm) (inch)	Spessore (S) (thickness)
F77/19	19 3/4	M
F77/25	25 1	M
F77/32	32 1-1/4	M
F77/38	38 1-1/2	M
F77/50	50 2	M

PIEDINI CONSIGLIATI
SUGGESTED FEET



G2460A - fino a 25 mm
G2470A - oltre 25 mm

F100 BORDATORE SEMPLICE

Per macchine piane
For flat bed machines

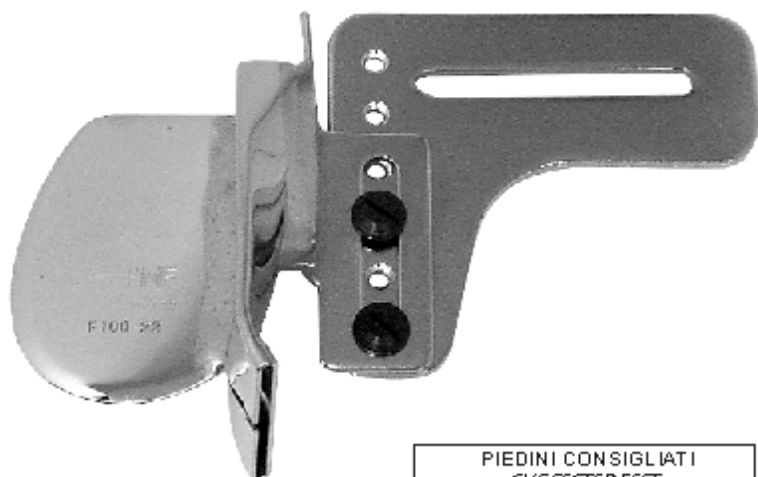

PIEDINI CONSIGLIATI
SUGGESTED FEET



 G601 fino a 4mm
 G602 fino a 5mm
 N603 fino a 6mm
 G604 fino a 7mm
 N605 oltre 8mm

SINGLE BINDER

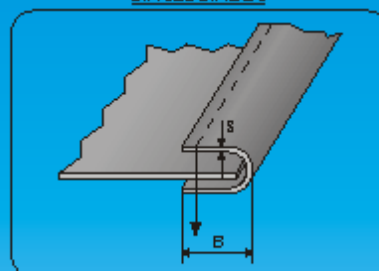

Codice	(A)	(B)	(S)	Codice	(A)	(B)	(S)
F 100/10	10	5	M	F 100/60	60	30	M
F 100/12	12	6	M	F 100/65	65	32,5	M
F 100/14	14	7	M	F 100/70	70	35	M
F 100/15	15	7,5	M				
F 100/16	16	8	M	F 100/12H	12	6	H
F 100/17	17	8,5	M	F 100/14H	14	7	H
F 100/18	18	9	M	F 100/15H	15	7,5	H
F 100/19	19	9,5	M	F 100/16H	16	8	H
F 100/20	20	10	M	F 100/19H	19	9,5	H
F 100/22	22	11	M	F 100/20H	20	10	H
F 100/25	25	12,5	M	F 100/22H	22	11	H
F 100/28	28	14	M	F 100/25H	25	12,5	H
F 100/30	30	15	M	F 100/28H	28	14	H
F 100/32	32	16	M	F 100/30H	30	15	H
F 100/35	35	17,5	M	F 100/32H	32	16	H
F 100/40	40	20	M	F 100/35H	35	17,5	H
F 100/45	45	22,5	M	F 100/40H	40	20	H
F 100/50	50	25	M	F 100/45H	45	22,5	H
F 100/55	55	27,5	M	F 100/50H	50	25	H

F100S BORDATORE SEMPLICE

Per macchine piane
For flat bed machines

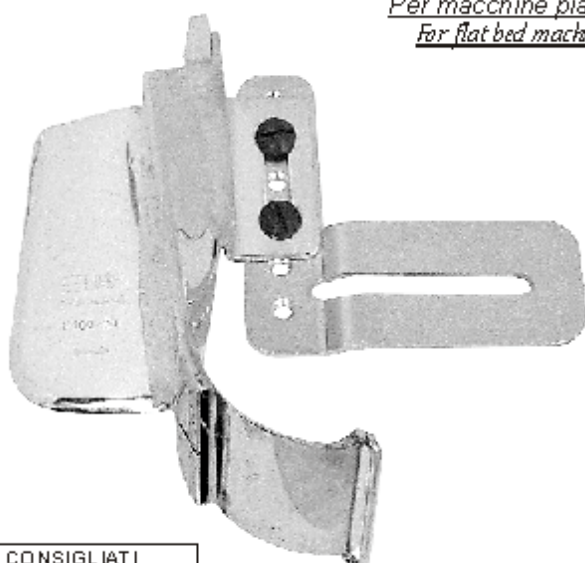

PIEDINI CONSIGLIATI
SUGGESTED FEET



 G601 fino a 4mm
 G602 fino a 5mm
 N603 fino a 6mm
 G604 fino a 7mm
 N605 oltre 8mm

SINGLE BINDER

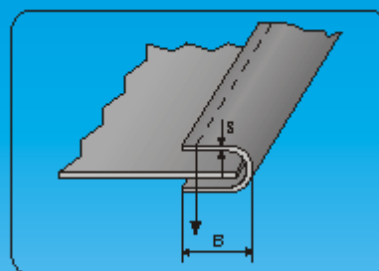

Codice	(A)	(B)	(S)	Codice	(A)	(B)	(S)
F 100S/20	20	10	M	F 100S/20H	20	10	H
F 100S/22	22	11	M	F 100S/22H	22	11	H
F 100S/25	25	12,5	M	F 100S/25H	25	12,5	H
F 100S/28	28	14	M	F 100S/28H	28	14	H
F 100S/30	30	15	M	F 100S/30H	30	15	H
F 100S/32	32	16	M	F 100S/32H	32	16	H
F 100S/35	35	17,5	M	F 100S/35H	35	17,5	H
F 100S/40	40	20	M	F 100S/40H	40	20	H
F 100S/45	45	22,5	M	F 100S/45H	45	22,5	H
F 100S/50	50	25	M	F 100S/50H	50	25	H
F 100S/55	55	27,5	M	F 100S/55H	55	27,5	H
F 100S/60	60	30	M	F 100S/60H	60	30	H

F100PL BORDATORE SEMPLICE PER FETTUCCE IN PLASTICA

Per macchine piane
For flat bed machines

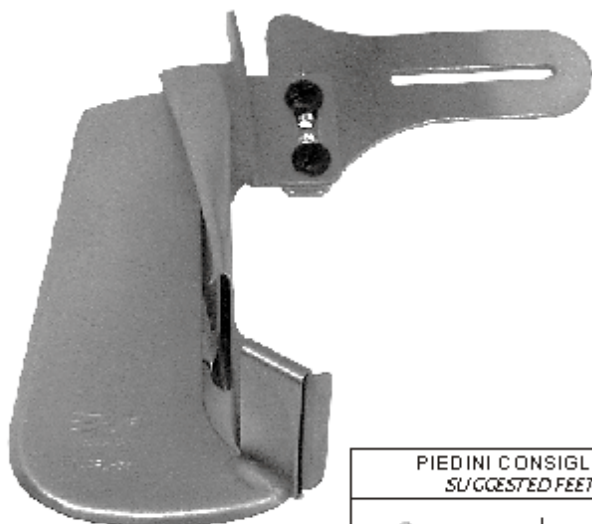

PIEDINI CONSIGLIATI
SUGGESTED FEET



- G601 fino a 4mm
- G602 fino a 5mm
- N603 fino a 6mm
- G604 fino a 7mm
- N605 oltre 8mm

SINGLE BINDER
FOR STIFF RIBBONS

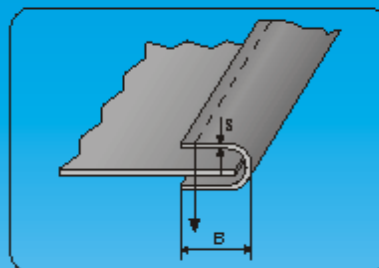

Codice	Entrata (A) (tape size) (mm) (inch)	Lav. finito (B) (finished size) (mm) (inch)	Spessore (S) (thickness)
F100PL/12	12 31/64	6 1/4	M
F100PL/14	14 9/16	7 9/32	M
F100PL/15	15 19/32	7,5 19/64	M
F100PL/16	16 5/8	8 5/16	M
F100PL/19	19 3/4	9,5 3/8	M
F100PL/20	20 25/32	10 25/64	M
F100PL/22	22 7/8	11 7/16	M
F100PL/25	25 1	12,5 1/2	M
F100PL/30	30 1-3/16	15 19/32	M
F100PL/35	35 1-3/8	17,5 11/16	M
F100PL/40	40 1-9/16	20 25/32	M
F100PL/45	45 1-3/4	22,5 7/8	M
F100PL/50	50 2	25 1	M

F1082 BORDATORE A PIEGA SEMPLICE INCLINATO

Per macchine piane
For flat bed machines

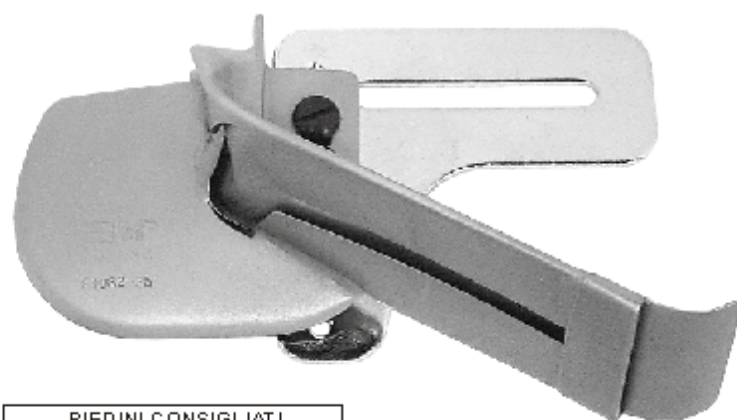

PIEDINI CONSIGLIATI
SUGGESTED FEET



- G601 fino a 4mm
- G602 fino a 5mm
- N603 fino a 6mm
- G604 fino a 7mm
- N605 oltre 8mm

SINGLE BINDER

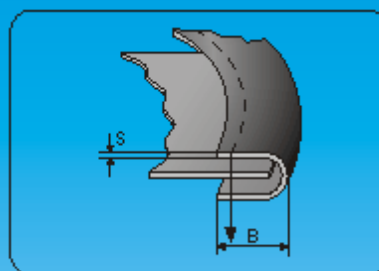

Codice	Entrata (A) (tape size) (mm) (inch)	Lav. finito (B) (finished size) (mm) (inch)	Spessore (S) (thickness)
F1082/10	10 25/64	5 3/16	M
F1082/12	12 31/64	6 1/4	M
F1082/14	14 9/16	7 9/32	M
F1082/16	16 5/8	8 5/16	M
F1082/18	18 23/32	9 23/64	M
F1082/20	20 25/32	10 25/64	M
F1082/22	22 7/8	11 7/16	M
F1082/24	24 15/166	12 15/32	M
F1082/26	26 1-1/32	13 33/64	M
F1082/28	28 1-1/8	14 9/16	M
F1082/30	30 1-3/16	15 19/32	M
F1082/32	32 1-1/4	16 5/8	M
F1082/35	35 1-3/8	17,5 11/16	M
F1082/38	38 1-1/2	19 3/4	M
F1082/40	40 1-9/16	20 25/32	M

F64 GRUPPO BORDATORE SU PLACCA PIEGA SEMPLICE

Per macchine piane
For flat bed machines

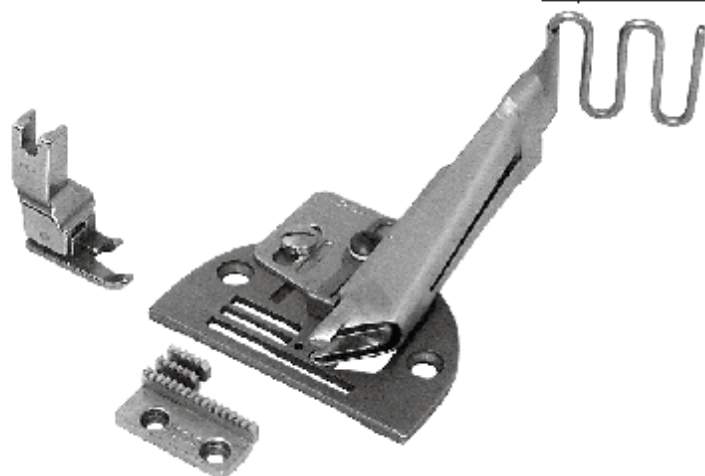

GRUPPI COMPLETI SEPARATI COMPLETE SETS - SEPARATED

[Placca, Griffa, Piedino] (Needle plate, Feed dog, Foot)

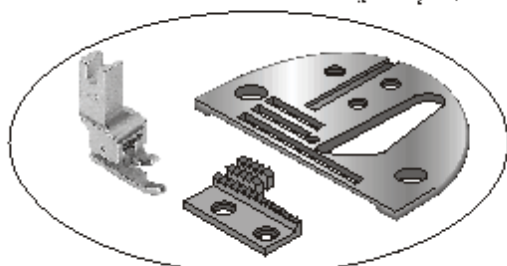

Per macchine (For machines):

PIANE (non rasafilo)

STRAIGHT STITCH (per Need. in inox)

- TIPO STANDARD
(STANDARD TYPE)

PLACCA Needle Plate	GRIFFA Feed Dog	PIEDINO Foot
cod. 12442	cod. 20002	a misura

LINEARE E ZIG-ZAG

STRAIGHT STITCH AND ZIGZAG

- BERNINA 217	(zig-zag)	cod. 15490	cod. 15492	cod. N60222
- BROTHER 856	(zig-zag)	cod. 15520	cod. 15521	cod. 15522
- DÜRKOPP 211	(rasafilo)	cod. 15500	cod. 15501	a misura
- DÜRKOPP 265	(zig-zag)	cod. 15510	cod. 15511	cod. N60222
- JUKI L22.280, 2290	(zig-zag)	cod. 15520	cod. 15521	cod. 15522
- NECCHI 720, 750	(zig-zag)	cod. 15560	cod. 15561	cod. N60222
- NECCHI 885	(rasafilo)	cod. 15565	cod. 15566	a misura
- PFAFF 138, 238	(zig-zag)	cod. 15600	cod. 15601
- PFAFF 438	(zig-zag)	cod. 15610	cod. 15611	cod. N60222
- PFAFF 463	(rasafilo)	cod. 15620	cod. 15621	a misura
- PFAFF 483		cod. 15630	cod. 15631	a misura
- PFAFF 487		cod. 15632	cod. 15633	cod. 15634
- REFREY 930	(zig-zag)	cod. 15490	cod. 15492	cod. N60222
- SINGER 457	(zig-zag)	cod. 15520	cod. 15521	cod. 15522

A RICHIESTA

possiamo fornire gruppi opl. (placca griffa e piedino) anche macchine diverse:
(BROTHER B737, B755, DÜRKOPP 271, PFAFF 407, RINGOLDI 140, ecc.)

UPON REQUEST

We can supply opl. sets (needle plate, feed dog, foot) also for different machines:
(BROTHER B737, B755, DÜRKOPP 271, PFAFF 407, RINGOLDI 140, etc.)

RIGHT ANGLE SINGLE BINDER SET

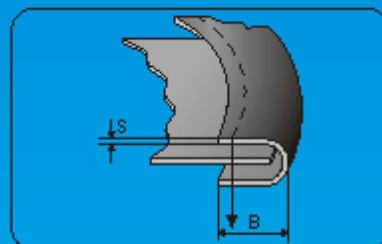

Codice	(A)	(B)	(S)	Codice	(A)	(B)	(S)
F64/10	10	5	M	F64/12H	12	6	H
F64/12	12	6	M	F64/14H	14	7	H
F64/14	14	7	M	F64/15H	15	7,5	H
F64/15	15	7,5	M	F64/16H	16	8	H
F64/16	16	8	M	F64/18H	18	9	H
F64/18	18	9	M	F64/19H	19	9,5	H
F64/19	19	9,5	M	F64/20H	20	10	H
F64/20	20	10	M	F64/22H	22	11	H
F64/22	22	11	M	F64/24H	24	12	H
F64/24	24	12	M	F64/25H	25	12,5	H
F64/25	25	12,5	M	F64/26H	26	13	H
F64/26	26	13	M	F64/28H	28	14	H
F64/28	28	14	M	F64/30H	30	15	H
F64/30	30	15	M	F64/32H	32	16	H
F64/32	32	16	M	F64/34H	34	17	H
F64/34	34	17	M	F64/35H	35	17,5	H
F64/35	35	17,5	M	F64/36H	36	18	H
F64/36	36	18	M	F64/38H	38	19	H
F64/38	38	19	M	F64/40H	40	20	H
F64/40	40	20	M				
F64/45	45	22,5	M				
F64/50	50	25	M				

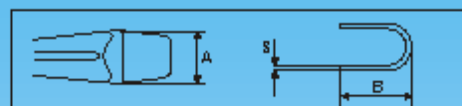

F64B

BECCUCCIO BORDATORE
SEPARATO
RIGHT ANGLE SINGLE BINDER



Codice	Codice	Codice	Codice
F64B/10	F64B/26	F64B/12H	F64B/30H
F64B/12	F64B/28	F64B/14H	F64B/32H
F64B/14	F64B/30	F64B/15H	F64B/34H
F64B/15	F64B/32	F64B/16H	F64B/35H
F64B/16	F64B/34	F64B/18H	F64B/38H
F64B/17	F64B/35	F64B/19H	F64B/40H
F64B/18	F64B/36	F64B/20H	
F64B/19	F64B/38	F64B/22H	
F64B/20	F64B/40	F64B/24H	
F64B/22	F64B/45	F64B/25H	
F64B/24	F64B/50	F64B/26H	
F64B/25		F64B/28H	

F62 GRUPPO BORDATORE SU PLACCA A 3 RISVOLTITI

Per macchine piane
For flat bed machines

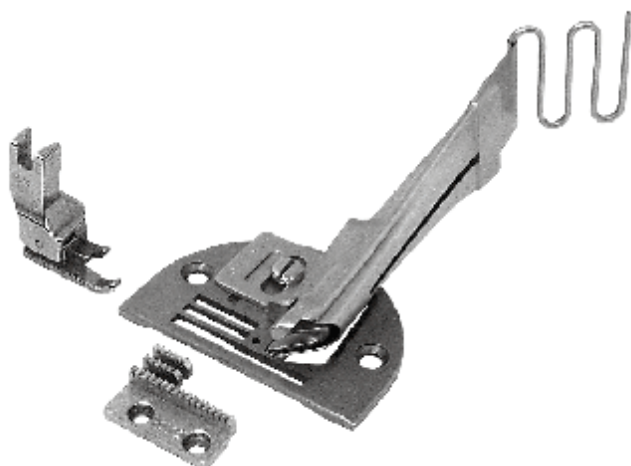

GRUPPI COMPLETI SEPARATI COMPLETE SETS - SEPARATED

(Placca, Griffa, Piedino) (Needle plate, Feed dog, Foot)

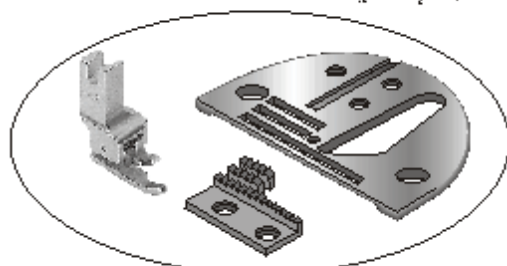

Per macchine (for machines):

PIANE (non rasafilo)

STRAIGHT STITCH (per tread trimmer)

- TIPO STANDARD
(STANDARD TYPE)

	PLACCA Needle Plate	GRIFFA Feed Dog	PIEDINO Foot
	cod. 12442	cod. 20002	a misura

LINEARI E ZIG-ZAG

STRAIGHT STITCH AND ZIG-ZAG

- BERNINA 217 (zig-zag)	cod. 15490	cod. 15492	cod. N60222
- BROTHER 856 (zig-zag)	cod. 15520	cod. 15521	cod. 15522
- DÜRKOPP 211 (rasafilo)	cod. 15500	cod. 15501	a misura
- DÜRKOPP 265 (zig-zag)	cod. 15510	cod. 15511	cod. N60222
- JUKI L22280, 2290 (zig-zag)	cod. 15520	cod. 15521	cod. 15522
- NECCHI 720, 750 (zig-zag)	cod. 15560	cod. 15561	cod. N60222
- NECCHI 885 (rasafilo)	cod. 15565	cod. 15566	a misura
- PFAFF 138, 238 (zig-zag)	cod. 15600	cod. 15601
- PFAFF 438 (zig-zag)	cod. 15610	cod. 15611	cod. N60222
- PFAFF 463 (rasafilo)	cod. 15620	cod. 15621	a misura
- PFAFF 483	cod. 15630	cod. 15631	a misura
- PFAFF 487	cod. 15632	cod. 15633	cod. 15634
- REFREY 930 (zig-zag)	cod. 15490	cod. 15492	cod. N60222
- SINGER 457 (zig-zag)	cod. 15520	cod. 15521	cod. 15522

A RICHIESTA

possiamo fornire gruppi cpl. (placca griffa e piedino) anche macchine diverse:
(BROTHER B737, B755, DÜRKOPP 271, PFAFF 467, RIMOLDI 140, ecc.)

UPON REQUEST

We can supply cpl. sets (needle plate, feed dog, foot) also for different machines:
(BROTHER B737, B755, DÜRKOPP 271, PFAFF 467, RIMOLDI 140, etc.)

RIGHT ANGLE SEMI-FOLD UPPER BINDER SET

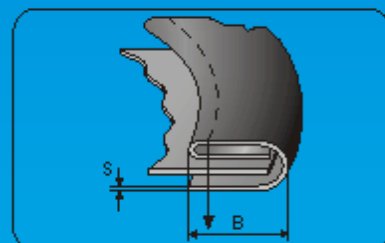

Codice	Entrata (A) (tape size) (mm) (inch)	Lav. finito (B) (finished size) (mm) (inch)	Spessore (S) (thickness) (mm) (inch)
F62/12	12 31/64	3 1/8	1,3 1/16
F62/14	14 9/16	4 5/32	1,3 1/16
F62/16	16 5/8	5 3/16	1,3 1/16
F62/19	19 3/4	5,5 7/32	1,3 1/16
F62/20	20 25/32	6 1/4	1,5 1/16
F62/22	22 7/8	7 9/32	1,5 1/16
F62/25	25 1	8 5/16	1,5 1/16
F62/28	28 1-1/8	9 23/64	1,5 1/16
F62/30	30 1-3/16	10 3/8	1,5 1/16
F62/32	32 1-1/4	11 7/16	1,5 1/16
F62/35	35 1-3/8	12 15/32	1,5 1/16
F62/38	38 1-1/2	14 9/16	1,5 1/16
F62/40	40 1-9/16	15 19/32	1,5 1/16

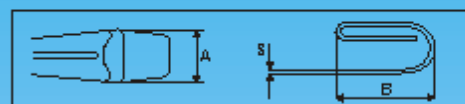

F62B

BECCUCCIO BORDATORE SEPARATO
RIGHT ANGLE SEMI-FOLD
UPPER BINDER



Codice	Entrata (A) (tape size) (mm) (inch)	Lav. finito (B) (finished size) (mm) (inch)	Spessore (S) (thickness) (mm) (inch)
F62B/12	12 31/64	3 1/8	1,3 1/16
F62B/14	14 9/16	4 5/32	1,3 1/16
F62B/16	16 5/8	5 3/16	1,3 1/16
F62B/19	19 3/4	5,5 7/32	1,3 1/16
F62B/20	20 25/32	6 1/4	1,5 1/16
F62B/22	22 7/8	7 9/32	1,5 1/16
F62B/25	25 1	8 5/16	1,5 1/16
F62B/28	28 1-1/8	9 23/64	1,5 1/16
F62B/30	30 1-3/16	10 3/8	1,5 1/16
F62B/32	32 1-1/4	11 7/16	1,5 1/16
F62B/35	35 1-3/8	12 15/32	1,5 1/16
F62B/38	38 1-1/2	14 9/16	1,5 1/16
F62B/40	40 1-9/16	15 19/32	1,5 1/16

F60 GRUPPO BORDATORE SU PLACCA DOPPIA PIEGA

Per macchine piane
For flat bed machines

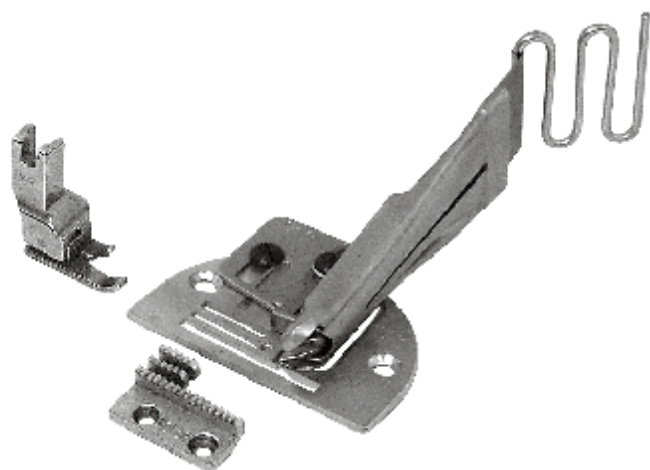

GRUPPI COMPLETI SEPARATI COMPLETE SETS - SEPARATED

[Placca, Griffa, Piedino] (Needle plate, Feed dog, Foot)

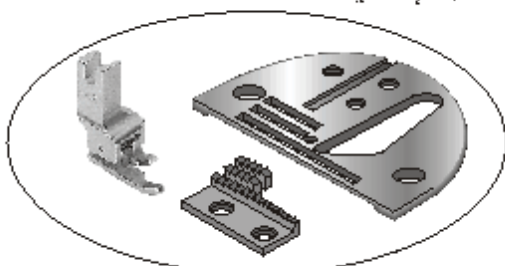

Per macchine (For machines):

PIANE (non rasafilo)

STRAIGHT STITCH (per Head in cover)

- TIPO STANDARD
(STANDARD TYPE)

PLACCA Needle Plate	GRIFFA Feed Dog	PIEDINO Foot
cod. 12442	cod. 20002	a misura

LINEARE E ZIG-ZAG

STRAIGHT STITCH AND ZIGZAG

- BERNINA 217	(zig-zag)	cod. 15490	cod. 15492	cod. N60222
- BROTHER 856	(zig-zag)	cod. 15520	cod. 15521	cod. 15522
- DÜRKOPP 211	(rasafilo)	cod. 15500	cod. 15501	a misura
- DÜRKOPP 265	(zig-zag)	cod. 15510	cod. 15511	cod. N60222
- JUKI L22.280, 2290	(zig-zag)	cod. 15520	cod. 15521	cod. 15522
- NECCHI 720, 750	(zig-zag)	cod. 15560	cod. 15561	cod. N60222
- NECCHI 885	(rasafilo)	cod. 15565	cod. 15566	a misura
- PFAFF 138, 238	(zig-zag)	cod. 15600	cod. 15601
- PFAFF 438	(zig-zag)	cod. 15610	cod. 15611	cod. N60222
- PFAFF 463	(rasafilo)	cod. 15620	cod. 15621	a misura
- PFAFF 483		cod. 15630	cod. 15631	a misura
- PFAFF 487		cod. 15632	cod. 15633	cod. 15634
- REFREY 930	(zig-zag)	cod. 15490	cod. 15492	cod. N60222
- SINGER 457	(zig-zag)	cod. 15520	cod. 15521	cod. 15522

A RICHIESTA

possiamo fornire gruppi opl. (placca griffa e piedino) anche macchine diverse:
(BROTHER B737, B755, DÜRKOPP 271, PFAFF 407, RINGOLDI 140, ecc.)

UPON REQUEST

We can supply opl. sets (needle plate, feed dog, foot) also for different machines:
(BROTHER B737, B755, DÜRKOPP 271, PFAFF 407, RINGOLDI 140, etc.)

RIGHT ANGLE DOUBLE BINDER SET

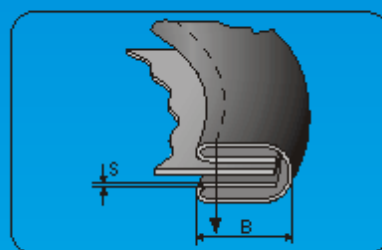

Codice	(A)	(B)	(S)	Codice	(A)	(B)	(S)
F60/14	14	3	M	F60/65	65	22,5	M
F60/16	16	4	M	F60/70	70	25	M
F60/18	18	4,5	M	F60/90	90	35	M
F60/19	19	4,7	M	F60/25H	25	7	H
F60/20	20	5	M	F60/28H	28	7,5	H
F60/22	22	6	M	F60/30H	30	8,5	H
F60/25	25	7	M	F60/32H	32	9,5	H
F60/28	28	8	M	F60/35H	35	10,5	H
F60/30	30	9	M	F60/38H	38	11	H
F60/32	32	10	M	F60/40H	40	11	H
F60/34	34	10	M	F60/42H	42	12	H
F60/35	35	11	M	F60/45H	45	13	H
F60/36	36	11	M	F60/48H	48	14	H
F60/38	38	11,5	M	F60/50H	50	15	H
F60/40	40	12	M	F60/35XH	35	10,5	XH
F60/42	42	13	M	F60/38XH	38	11	XH
F60/45	45	14	M	F60/40XH	40	11	XH
F60/48	48	15	M	F60/42XH	42	12	XH
F60/50	50	16	M	F60/45XH	45	13	XH
F60/55	55	17,5	M	F60/48XH	48	14	XH
F60/60	60	20	M	F60/50XH	50	15	XH

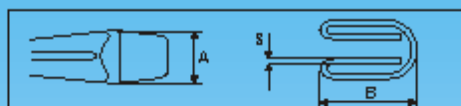

F60B

BECCUCCIO BORDATORE
SEPARATO
RIGHT ANGLE DOUBLE BINDER

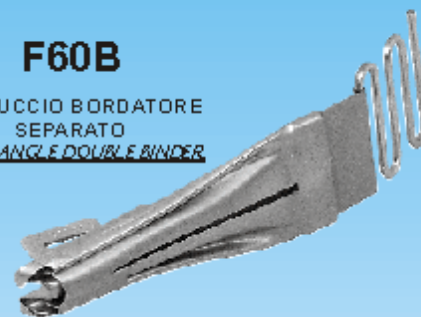

Codice	Codice	Codice	Codice
F60B/14	F60B/36	F60B/25H	F60B/35XH
F60B/16	F60B/38	F60B/28H	F60B/38XH
F60B/18	F60B/40	F60B/30H	F60B/40XH
F60B/19	F60B/42	F60B/32H	F60B/42XH
F60B/20	F60B/45	F60B/35H	F60B/45XH
F60B/22	F60B/48	F60B/38H	F60B/48XH
F60B/25	F60B/50	F60B/40H	F60B/50XH
F60B/28	F60B/55	F60B/42H	
F60B/30	F60B/60	F60B/45H	
F60B/32	F60B/65	F60B/48H	
F60B/34	F60B/70	F60B/50H	
F60B/35	F60B/90		

F185B BORDATORE SU PLACCA - DOPPIA PIEGA CON INSERIMENTO DI ELASTICO

Per macchine piane zig-zag
For zig-zag flat bed machines

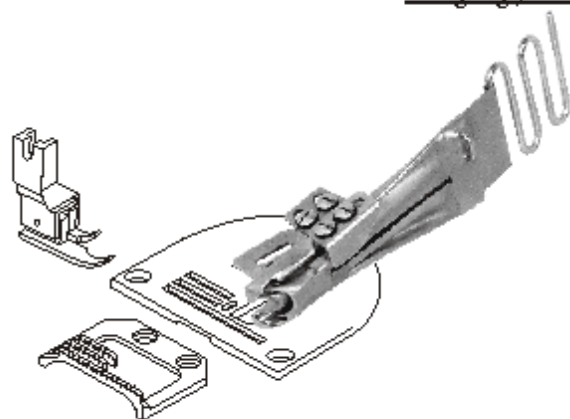

RIGHT ANGLE DOUBLE BINDER
FOR ELASTIC INSERTION

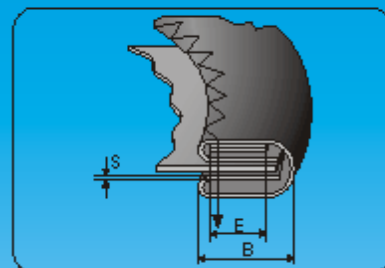

GRUPPI COMPLETI - SEPARATI COMPLETE SETS - SEPARATED

(Placca, Griffa, Piedino)

(Needle plate, Feed dog, Foot)

		PLACCA Needle Plate	GRIFFA Feed Dog	PIEDINO Foot
- BERNINA 217	(zig-zag)	cod. 15490	cod. 15492	cod. N60222
- BROTHER 856	(zig-zag)	cod. 15520	cod. 15521	cod. 15522
- DÜRKOPP 265	(zig-zag)	cod. 15510	cod. 15511	cod. N60222
- JUKI LZ2280, 2290	(zig-zag)	cod. 15520	cod. 15521	cod. 15522
- NECCHI 720, 750	(zig-zag)	cod. 15560	cod. 15561	cod. N60222
- PFAFF 138, 238	(zig-zag)	cod. 15600	cod. 15601	-----
- PFAFF 438	(zig-zag)	cod. 15610	cod. 15611	cod. N60222
- REFREY 930	(zig-zag)	cod. 15490	cod. 15492	cod. N60222
- SINGER 457	(zig-zag)	cod. 15520	cod. 15521	cod. 15522

Codice (SOLO BECCUCCIO)	Entrata (A) (tape size)		Lav. finito (B) (finished size)		Bastico (E) (elastic size)	
	(mm)	(inch)	(mm)	(inch)	(mm)	(inch)
F185B/20M	20	25/32	5	3/16	4	5/32
F185B/22M	22	7/8	6	1/4	5	3/16
F185B/25M	25	1	7	9/32	6	1/4
F185B/28M	28	1-1/8	8	5/16	7	9/32
F185B/30M	30	1-3/16	9	11/32	8	5/16
F185B/32M	32	1-1/4	10	3/8	9	11/32
F185B/35M	35	1-3/8	11	7/16	10	3/8
F185B/38M	38	1-1/2	12	1/2	10	3/8
F185B/40M	40	1-9/16	13	33.64	12	1/2
F185B/42M	42	1-21/32	14	9/16	12	1/2
F185B/45M	45	1-3/4	15	19.02	14	9/16

F186B BORDATORE SU PLACCA DOPPIA PIEGA CON INSERIMENTO DI ELASTICO E FRENAGGIO

Per macchine piane zig-zag
For zig-zag flat bed machines

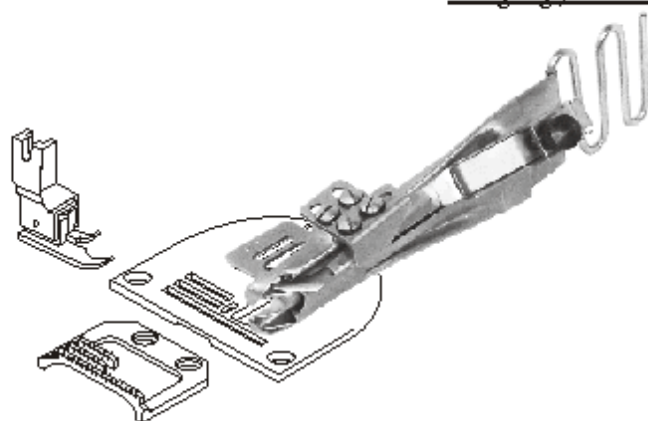

RIGHT ANGLE DOUBLE BINDER
FOR ELASTIC INSERTION

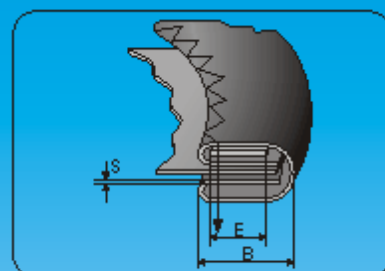

GRUPPI COMPLETI - SEPARATI COMPLETE SETS - SEPARATED

(Placca, Griffa, Piedino)

(Needle plate, Feed dog, Foot)

		PLACCA Needle Plate	GRIFFA Feed Dog	PIEDINO Foot
- BERNINA 217	(zig-zag)	cod. 15490	cod. 15492	cod. N60222
- BROTHER 856	(zig-zag)	cod. 15520	cod. 15521	cod. 15522
- DÜRKOPP 265	(zig-zag)	cod. 15510	cod. 15511	cod. N60222
- JUKI LZ2280, 2290	(zig-zag)	cod. 15520	cod. 15521	cod. 15522
- NECCHI 720, 750	(zig-zag)	cod. 15560	cod. 15561	cod. N60222
- PFAFF 138, 238	(zig-zag)	cod. 15600	cod. 15601	-----
- PFAFF 438	(zig-zag)	cod. 15610	cod. 15611	cod. N60222
- REFREY 930	(zig-zag)	cod. 15490	cod. 15492	cod. N60222
- SINGER 457	(zig-zag)	cod. 15520	cod. 15521	cod. 15522

Codice (SOLO BECCUCCIO)	Entrata (A) (tape size)		Lav. finito (B) (finished size)		Bastico (E) (elastic size)	
	(mm)	(inch)	(mm)	(inch)	(mm)	(inch)
F185B/20M	20	25/32	5	3/16	4	5/32
F185B/22M	22	7/8	6	1/4	5	3/16
F185B/25M	25	1	7	9/32	6	1/4
F185B/28M	28	1-1/8	8	5/16	7	9/32
F185B/30M	30	1-3/16	9	11/32	8	5/16
F185B/32M	32	1-1/4	10	3/8	9	11/32
F185B/35M	35	1-3/8	11	7/16	10	3/8
F185B/38M	38	1-1/2	12	1/2	10	3/8
F185B/40M	40	1-9/16	13	33.64	12	1/2
F185B/42M	42	1-21/32	14	9/16	12	1/2
F185B/45M	45	1-3/4	15	19.02	14	9/16

F495B BORDATORE SU PLACCA - DOPPIA PIEGA CON INSERIMENTO DI ELASTICO

Per macchine piane zig-zag
For zig-zag flat bed machines

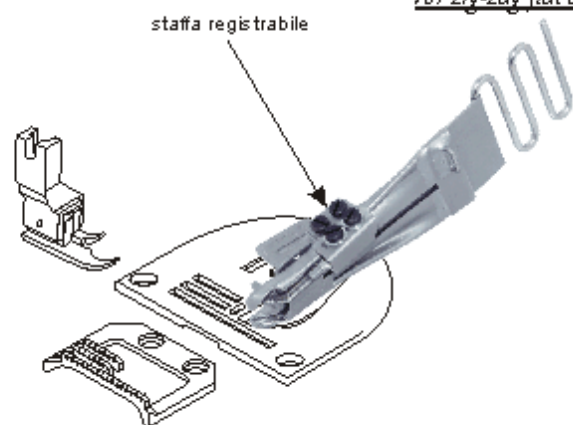

GRUPPI COMPLETI - SEPARATI COMPLETE SETS - SEPARATED

(Placca, Griffa, Piedino)

(Needle plate, Feed dog, Foot)

		PLACCA Needle Plate	GRIFFA Feed Dog	PIEDINO Foot
- BERNINA 217 (zig-zag)	cod. 15490	cod. 15490	cod. 15492	cod. N60222
- BROTHER 856 (zig-zag)	cod. 15520	cod. 15520	cod. 15521	cod. 15522
- DÜRKOPP 265 (zig-zag)	cod. 15510	cod. 15510	cod. 15511	cod. N60222
- JUKI L22280, 2290 (zig-zag)	cod. 15520	cod. 15520	cod. 15521	cod. 15522
- NECCHI 720, 750 (zig-zag)	cod. 15560	cod. 15560	cod. 15561	cod. N60222
- PFAFF 138, 238 (zig-zag)	cod. 15600	cod. 15600	cod. 15601	-----
- PFAFF 438 (zig-zag)	cod. 15610	cod. 15610	cod. 15611	cod. N60222
- REFREY 930 (zig-zag)	cod. 15490	cod. 15490	cod. 15492	cod. N60222
- SINGER 457 (zig-zag)	cod. 15520	cod. 15520	cod. 15521	cod. 15522

RIGHT ANGLE DOUBLE BINDER
FOR ELASTIC INSERTION

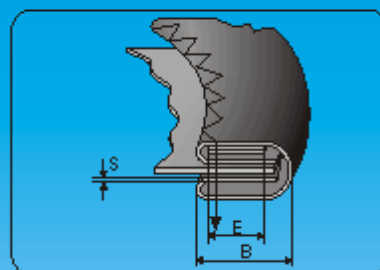

Codice (SOLO BECCUCCIO)	Entrata (A) (tape size) (mm) (inch)	Lav. finito (B) (finished size) (mm) (inch)	Elastico (E) (elastic size) (mm) (inch)
F495B/20M	20 25/32	5 3/16	4 5/32
F495B/22M	22 7/8	6 1/4	5 3/16
F495B/25M	25 1	7 9/32	6 1/4
F495B/28M	28 1-1/8	8 5/16	7 9/32
F495B/30M	30 1-3/16	9 11/32	8 5/16
F495B/32M	32 1-1/4	10 3/8	9 11/32
F495B/35M	35 1-3/8	11 7/16	10 3/8
F495B/38M	38 1-1/2	12 1/2	10 3/8
F495B/40M	40 1-9/16	13 33/64	12 1/2
F495B/42M	42 1-21/32	14 9/16	12 1/2
F495B/45M	45 1-3/4	15 19/32	14 9/16

F487B BORDATORE SU PLACCA - DOPPIA PIEGA CON INSERIMENTO DI ELASTICO

Per macchine piane zig-zag
For zig-zag flat bed machines

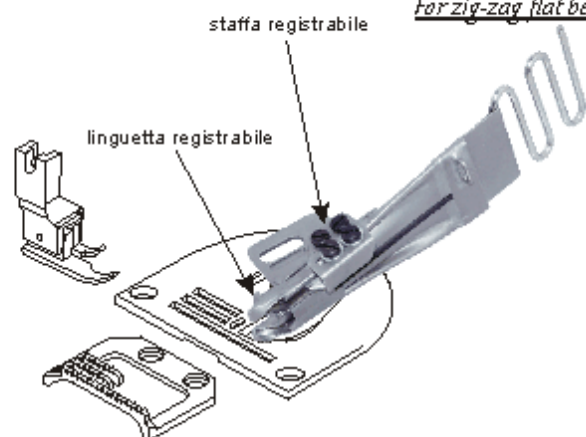

GRUPPI COMPLETI - SEPARATI COMPLETE SETS - SEPARATED

(Placca, Griffa, Piedino)

(Needle plate, Feed dog, Foot)

		PLACCA Needle Plate	GRIFFA Feed Dog	PIEDINO Foot
- BERNINA 217 (zig-zag)	cod. 15490	cod. 15490	cod. 15492	cod. N60222
- BROTHER 856 (zig-zag)	cod. 15520	cod. 15520	cod. 15521	cod. 15522
- DÜRKOPP 265 (zig-zag)	cod. 15510	cod. 15510	cod. 15511	cod. N60222
- JUKI L22280, 2290 (zig-zag)	cod. 15520	cod. 15520	cod. 15521	cod. 15522
- NECCHI 720, 750 (zig-zag)	cod. 15560	cod. 15560	cod. 15561	cod. N60222
- PFAFF 138, 238 (zig-zag)	cod. 15600	cod. 15600	cod. 15601	-----
- PFAFF 438 (zig-zag)	cod. 15610	cod. 15610	cod. 15611	cod. N60222
- REFREY 930 (zig-zag)	cod. 15490	cod. 15490	cod. 15492	cod. N60222
- SINGER 457 (zig-zag)	cod. 15520	cod. 15520	cod. 15521	cod. 15522

RIGHT ANGLE DOUBLE BINDER
FOR ELASTIC INSERTION

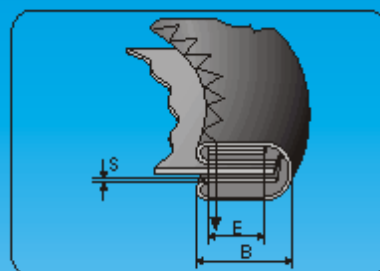

Codice (SOLO BECCUCCIO)	Entrata (A) (tape size) (mm) (inch)	Lav. finito (B) (finished size) (mm) (inch)	Elastico (E) (elastic size) (mm) (inch)
F487B/20M	20 25/32	5 3/16	4 5/32
F487B/22M	22 7/8	6 1/4	5 3/16
F487B/25M	25 1	7 9/32	6 1/4
F487B/28M	28 1-1/8	8 5/16	7 9/32
F487B/30M	30 1-3/16	9 11/32	8 5/16
F487B/32M	32 1-1/4	10 3/8	9 11/32
F487B/35M	35 1-3/8	11 7/16	10 3/8
F487B/38M	38 1-1/2	12 1/2	10 3/8
F487B/40M	40 1-9/16	13 33/64	12 1/2
F487B/42M	42 1-21/32	14 9/16	12 1/2
F487B/45M	45 1-3/4	15 19/32	14 9/16

F435 BORDATORE PER ELASTICO

Per macchine piane zig zag
For flat bed zig zag machines

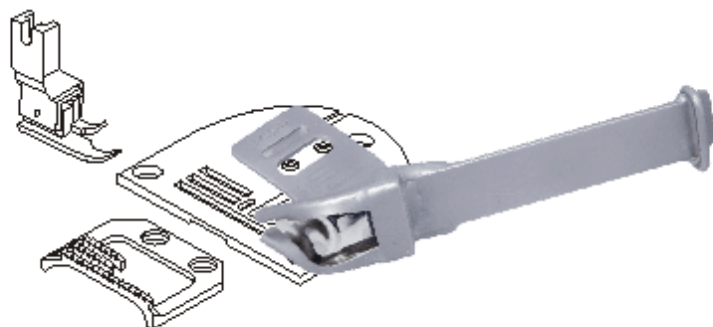

BINDER FOR ELASTIC

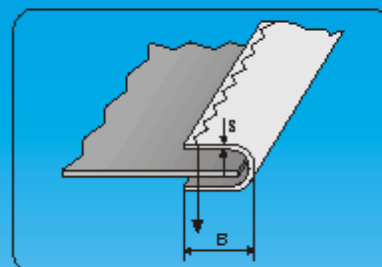

GRUPPI COMPLETI - SEPARATI COMPLETE SETS - SEPARATED

(Placca, Griffa, Piedino)

(Needle plate, Feed dog, Foot)

		PLACCA Needle Plate	GRIFFA Feed Dog	PIEDINO Foot
- BERNINA 217	(zig-zag)	cod. 15490	cod. 15492	cod. N60222
- BROTHER 856	(zig-zag)	cod. 15520	cod. 15521	cod. 15522
- DÜRKOPP 265	(zig-zag)	cod. 15510	cod. 15511	cod. N60222
- JUKI LZ2280, 2290	(zig-zag)	cod. 15520	cod. 15521	cod. 15522
- NECCHI 720, 750	(zig-zag)	cod. 15560	cod. 15561	cod. N60222
- PFAFF 138, 238	(zig-zag)	cod. 15600	cod. 15601	-----
- PFAFF 438	(zig-zag)	cod. 15610	cod. 15611	cod. N60222
- REFREY 930	(zig-zag)	cod. 15490	cod. 15492	cod. N60222
- SINGER 457	(zig-zag)	cod. 15520	cod. 15521	cod. 15522

Codice	Entrata (A) (tape size) (mm) (inch)	Lav. finito (B) (finished size) (mm) (inch)	Spessore (S) (thickness)
F435/12	12 15/32	6 1/4	M
F435/14	14 9/16	7 9/32	M
F435/15	15 19/32	7,5 19/64	M
F435/16	16 5/8	8 5/16	M
F435/18	18 23/32	9 11/32	M
F435/20	20 25/32	10 3/8	M
F435/22	22 7/8	11 7/16	M
F435/25	25 1	12,5 1/2	M
F435/30	30 1-3/16	15 5/8	M

F438 BORDATORE A 3 RISVOLTI SFALSATO LARGO

Per macchine piane
For flat bed machines

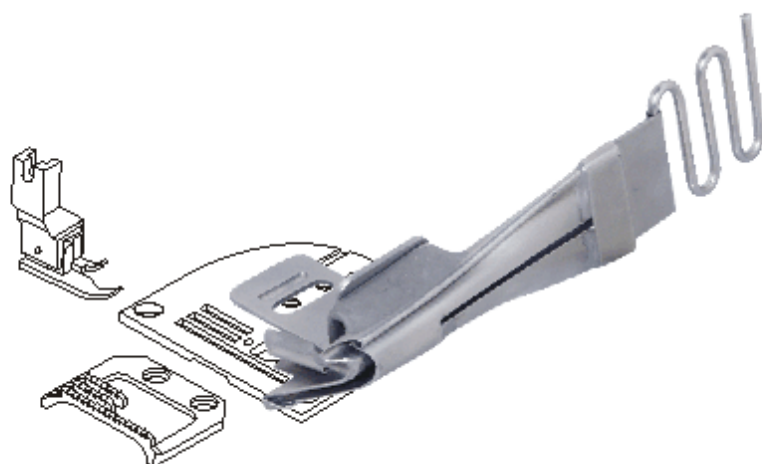

RIGHT ANGLE SEMI-FOLD UPPER BINDER
WIDE BOTTOM

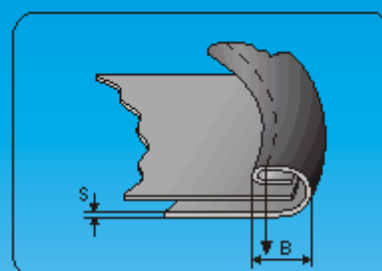

NOTA:
per i gruppi completi separati fare
riferimento alla tabella a pag. 34

NOTE:
for the complete sets separated you
must see the schedule at page 34

Codice	Entrata (A) (tape size) (mm)	Lav. finito (B) (finished size) (mm)	Spessore (S) (thickness)
--------	------------------------------------	--	-----------------------------

L'APPARECCHIO VIENE FORNITO SU RICHIESTA
Con l'ordinazione è necessario che ci siano inviati sia
il campione della fettuccia che deve essere utilizzata,
sia il campione del materiale che deve essere bordato.

MANUFACTURED ON REQUEST

With the order we need to receive both sample of tape
to be used and sample of material to be binded.

F34000

**BORDATORE AD ANGOLO
PIEGA SEMPLICE (115°)**

*Per macchine triplice trasporto
For walking foot machines*

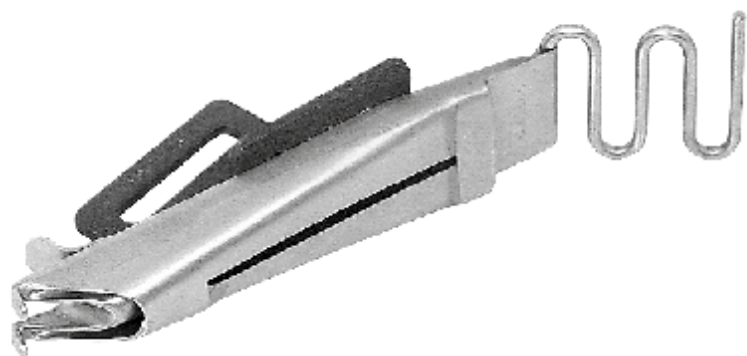
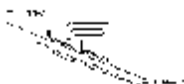

F34000A - staffa
-bracket



RIGHT ANGLE SINGLE BINDER (115°)

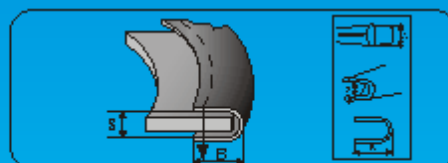

Codice	(A)	(S)	(B)	Codice	(A)	(S)	(B)
F34000/12x4	12	4	4	F34000/28x4	28	4	12
F34000/14x4	14	4	5	F34000/28x5	28	5	11,5
F34000/14x5	14	5	4,5	F34000/28x6	28	6	11
F34000/15x5	15	5	5	F34000/28x7	28	7	10,5
F34000/16x4	16	4	6	F34000/28x8	28	8	10
F34000/16x5	16	5	5,5	F34000/30x4	30	4	13
F34000/16x6	16	6	5	F34000/30x5	30	5	12,5
F34000/18x4	18	4	7	F34000/30x6	30	6	12
F34000/18x5	18	5	6,5	F34000/32x4	32	4	14
F34000/18x6	18	6	6	F34000/32x5	32	5	13,5
F34000/20x4	20	4	8	F34000/32x6	32	6	13
F34000/20x5	20	5	7,5	F34000/35x4	35	4	15,5
F34000/20x6	20	6	7	F34000/35x5	35	5	15
F34000/20x7	20	7	6,5	F34000/35x6	35	6	14,5
F34000/22x4	22	4	9	F34000/40x4	40	4	1
F34000/22x5	22	5	8,5	F34000/40x5	40	5	17,5
F34000/22x6	22	6	8	F34000/40x6	40	6	17
F34000/22x7	22	7	7,5	F34000/45x4	45	4	20,5
F34000/24x6	24	6	9	F34000/45x8	45	8	18,5
F34000/25x4	25	4	10,5	F34000/50x4	50	4	23
F34000/25x5	25	5	10	F34000/50x8	50	8	21
F34000/25x6	25	6	9,5	F34000/60x4	60	4	28
F34000/25x8	25	8	8,5	F34000/60x6	60	6	27

F34001

**BORDATORE AD ANGOLO
A 3 RISVOLTI (115°)**

*Per macchine triplice trasporto
For walking foot machines*

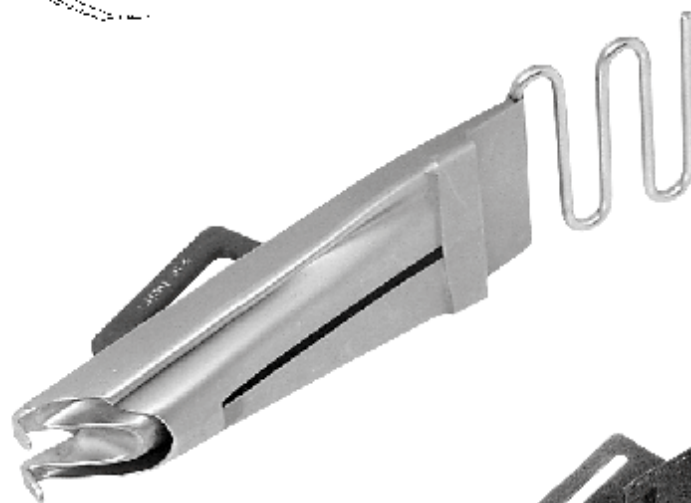
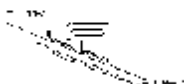

F34000A - staffa
-bracket



RIGHT ANGLE SEMI-FOLD BINDER (115°)

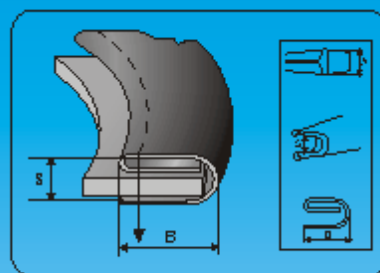

Codice	(A)	(S)	(B)	Codice	(A)	(S)	(B)
F34001/14x4	14	4	3	F34001/28x5	28	5	10
F34001/16x4	16	4	4	F34001/28x6	28	6	10
F34001/19x5	19	5	4,5	F34001/28x7	28	7	10
F34001/20x4	20	4	7	F34001/30x4	30	4	11
F34001/20x5	20	5	7	F34001/30x5	30	5	11
F34001/20x6	20	6	7	F34001/30x6	30	6	11
F34001/22x4	22	4	8	F34001/30x8	30	8	11
F34001/22x5	22	5	8	F34001/35x5	35	5	13
F34001/22x6	22	6	8	F34001/35x6	35	6	13
F34001/24x6	24	6	8	F34001/35x8	35	8	13
F34001/25x4	25	4	9				
F34001/25x5	25	5	9				
F34001/25x6	25	6	9				
F34001/27x5	27	5	9,5				
F34001/28x4	28	4	10				

F34002 BORDATORE AD ANGOLO DOPPIA PIEGA (115°)

Per macchine triplice trasporto
For walking foot machines

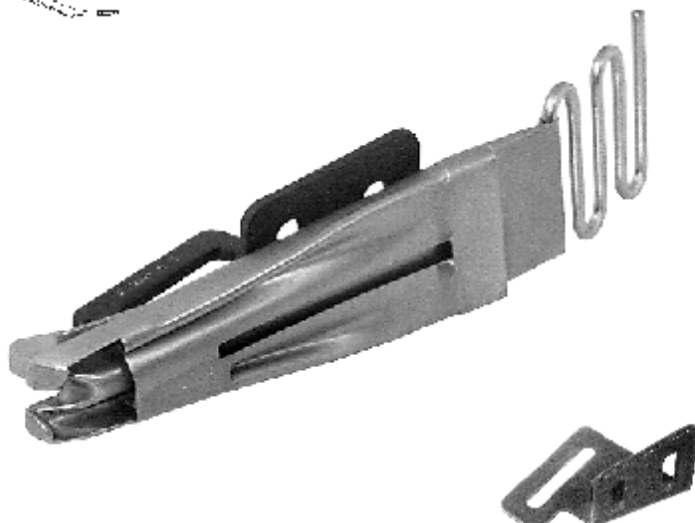

F34000A - staffa
-bracket



RIGHT ANGLE DOUBLE BINDER (115°)

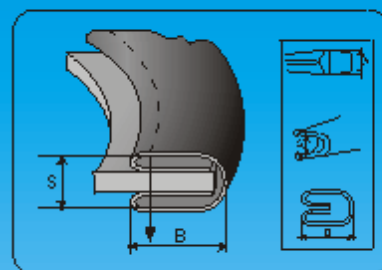

Codice				Codice			
	(A)	(S)	(B)		(A)	(S)	(B)
F34002/20x4	20	4	5	F34002/32x6	32	6	10
F34002/20x5	20	5	4	F34002/35x5	35	5	11
F34002/22x4	22	4	6	F34002/35x6	35	6	10,5
F34002/22x5	22	5	5,5	F34002/35x7	35	7	10,5
F34002/22x6	22	6	5,5	F34002/40x5	40	5	12
F34002/25x4	25	4	7	F34002/40x7	40	7	11,5
F34002/25x5	25	5	6,5	F34002/40x8	40	8	11,5
F34002/25x6	25	6	6,5	F34002/45x5	40	8	12,5
F34002/28x4	28	4	8	F34002/45x6	40	8	12,5
F34002/28x5	28	5	7,5	F34002/45x7	40	8	12,5
F34002/28x6	28	6	7,5	F34002/45x8	40	8	12,5
F34002/30x4	30	4	9				
F34002/30x5	30	5	8,5				
F34002/30x6	30	6	8,5				
F34002/30x7	30	7	8				

F29000 BORDATORE AD ANGOLO A PIEGA SEMPLICE (95°)

Per macchine triplice trasporto
For walking foot machines

السلاسل

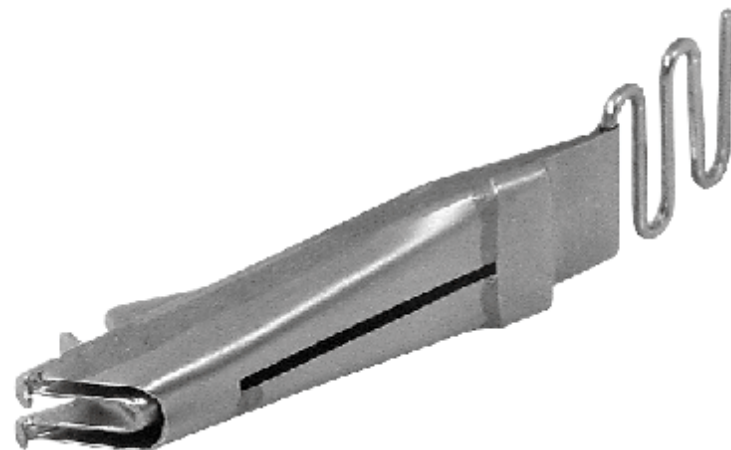

RIGHT ANGLE SINGLE BINDER (95°)

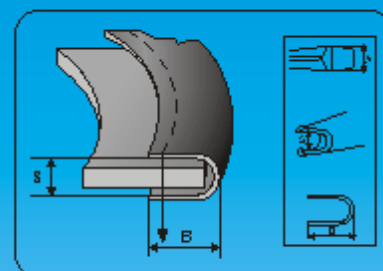

Codice	Entrata (A) (tape size)		Lav. finito (B) (finished size)		Spessore (S) (thickness)	
	(mm)	(inch)	(mm)	(inch)	(mm)	(inch)
F29000/12x6x3	12	31/64	6	1/4	3	1/8
F29000/14x7x4	14	9/16	7	9/32	4	5/32
F29000/16x8x4	16	5/8	8	5/16	4	5/32
F29000/18x9x4	18	23/32	9	23/64	4	5/32
F29000/19x9x6	19	3/4	9	23/64	6	1/4
F29000/20x10x4	20	25/32	10	25/64	4	5/32
F29000/20x10x6	20	25/32	10	25/64	6	1/4
F29000/22x11x4	22	7/8	11	7/16	4	5/32
F29000/22x11x6	22	7/8	11	7/16	6	1/4
F29000/24x12x4	24	15/16	12	15/32	4	5/32
F29000/24x12x6	24	15/16	12	15/32	6	1/4
F29000/26x13x4	26	1-1/32	13	33/64	4	5/32
F29000/26x13x6	26	1-1/32	13	33/64	6	1/4
F29000/28x14x6	28	1-1/8	14	9/16	6	1/4
F29000/30x15x6	30	1-3/16	15	19/32	6	1/4
F29000/35x17x6	35	1-3/8	17	21/32	6	1/4
F29000/40x20x6	40	1-9/16	20	25/32	6	1/4

F29002 BORDATORE AD ANGOLO DOPPIA PIEGA (95°)

Per macchine triplice trasporto
For walking foot machines

السلاسل

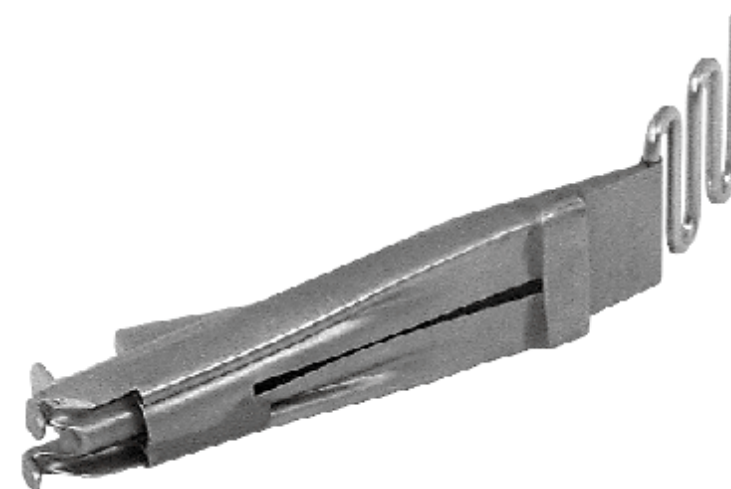

RIGHT ANGLE DOUBLE BINDER (95°)

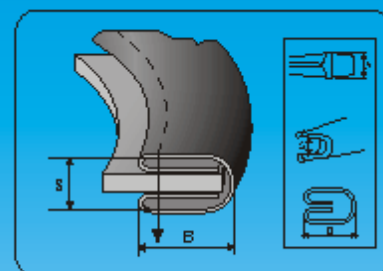

Codice	Entrata (A) (tape size)		Lav. finito (B) (finished size)		Spessore (S) (thickness)	
	(mm)	(inch)	(mm)	(inch)	(mm)	(inch)
F29002/20x5x4	20	25/32	5	3/16	4	5/32
F29002/22x6x4	22	7/8	6	1/4	4	5/32
F29002/25x7x4	25	1	7	9/32	4	5/32
F29002/25x7x5	25	1	7	9/32	5	3/16
F29002/25x7x6	25	1	7	9/32	6	1/4
F29002/28x8x4	28	1-1/8	8	5/16	4	5/32
F29002/28x8x6	28	1-1/8	8	5/16	6	1/4
F29002/30x9x4	30	1-3/16	9	23/64	4	5/32
F29002/30x9x6	30	1-3/16	9	23/64	6	1/4
F29002/35x11x5	35	1-3/8	11	7/16	5	3/16
F29002/35x11x7	35	1-3/8	11	7/16	7	9/32
F29002/40x13x7	40	1-9/16	13	33/64	7	9/32

F1245 BORDATORE PER CINTURE PER FETTUCCE CONTINUE

Per macchine a 4 aghi
For 4 needle machines

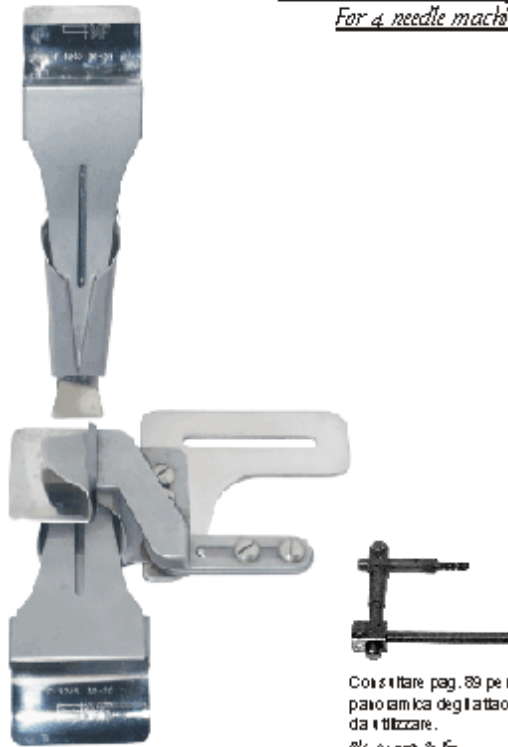

Costituito pag. 89 per il
paio omico degli attacchi
da utilizzare.
Pls. see page 89 for
the brackets to be used

*WAIST BAND FOLDER
FOR CONTINUOUS STRIPS*

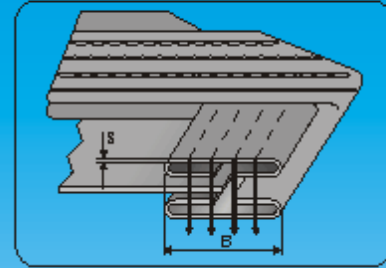

Codice	Entrata (A) (tape size) (mm) (inch)	Lav. finito (B) (finished size) (mm) (inch)	Spessore (S) (thickness)
F 1245/38	38 1-1/2	22 7/8	MH
F 1245/52	52 2-3/8	30 1-3/16	MH
F 1245/58	58 2-9/32	36 1-7/16	MH
F 1245/65	65 2-19/32	43 1-11/16	MH

F31000 BORDATORE AD ANGOLO PER CINTURE - PIEGA SEMPLICE

Per macchine multiaghi
For multineedle machines

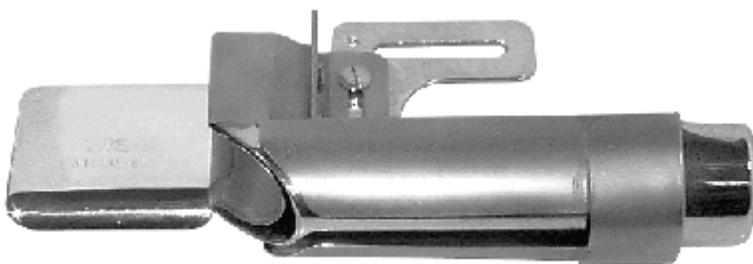

*SINGLE ELBOW BINDER
FOR WAIST BANDS*

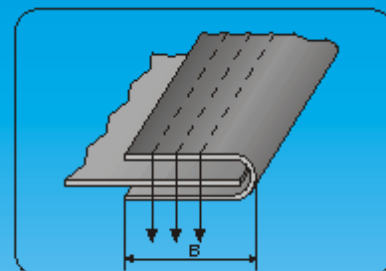

Codice	Entrata (A) (tape size) (mm)	Lav. finito (B) (finished size) (mm)	Spessore (S) (thickness)

L'APPARECCHIO VIENE FORNITO SU RICHIESTA

Con l'ordinazione è necessario che ci siano inviati sia
il campione della fettuccia che deve essere utilizzata,
sia il campione del materiale che deve essere bordato.

MANUFACTURED ON REQUEST

With the order we need to receive both sample of tape
to be used and sample of material to be binded.

L'APPARECCHIO VIENE
FORNITO COMPLETO
DI ATTACCO UNIVERSALE

THE ATTACHMENT IS SUPPLIED
WITH UNIVERSAL BRACKET



F31001S

tipo "UNIVERSALE"
"UNIVERSAL" type

ATTACCO A RICHIESTA
UPON REQUEST BRACKET

tipo "RIMOLDI"
"REIMOLD" type



F31001R

F31001 BORDATORE AD ANGOLO PER CINTURE - DOPPIA PIEGA

Per macchine a 4 aghi
For 4 needle machines

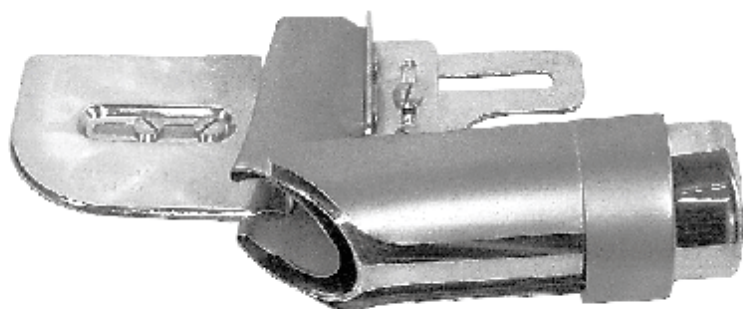

DOUBLE ELBOW BINDER
FOR WAIST BANDS

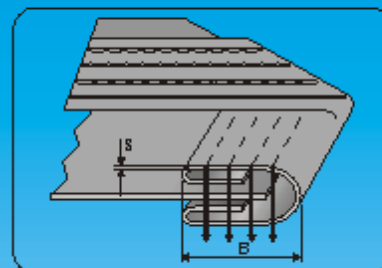

L'APPARECCHIO VIENE FORNITO COMPLETO DI ATTACCO UNIVERSALE

THE ATTACHMENT IS SUPPLIED WITH UNIVERSAL BRACKET

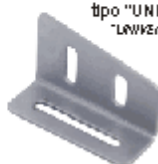

F31001S

tipo "UNIVERSALE"
"UNIVERSAL" type

ATTACCO A RICHIESTA
UPON REQUEST BRACKET

tipo "RIMOLDI"
"RIMOLDI" type



F31001R

Codice	Entrata (A) (tape size) (mm)	Entrata (A) (lock)	Lav. finito (B) (finished size) (mm)	Lav. finito (B) (lock)	Spessore (S) (thickness)
F31001/60	60	2-3/8	22	7/8	L-M
F31001/70	70	2-3/4	25	1	L-M
F31001/75	75	3	27	1-3/32	L-M
F31001/80	80	3-3/16	28	1-1/8	L-M-MH-H
F31001/85	85	3-3/8	30	1-3/16	L-M-MH-H
F31001/90	90	3-9/16	32	1-1/4	L-M-MH-H-XH
F31001/95	95	3-3/4	36	1-7/16	L-M-MH-H
F31001/100	100	4	39	1-9/16	L-M-MH-H
F31001/105	105	4-3/16	43	1-23/32	L-M-MH-H
F31001/110	110	4-25/64	45	1-3/4	L-M-MH-H
F31001/120	120	4-25/32	50	2	L-M-H-XH
F31001/130	130	5-3/16	55	2-3/16	M-H
F31001/140	140	5-9/16	60	2-3/8	M-H

F31002 BORDATORE DOPPIA PIEGA CON INSERIMENTO DI PROFILO

Per macchine a 4 aghi
For 4 needle machines

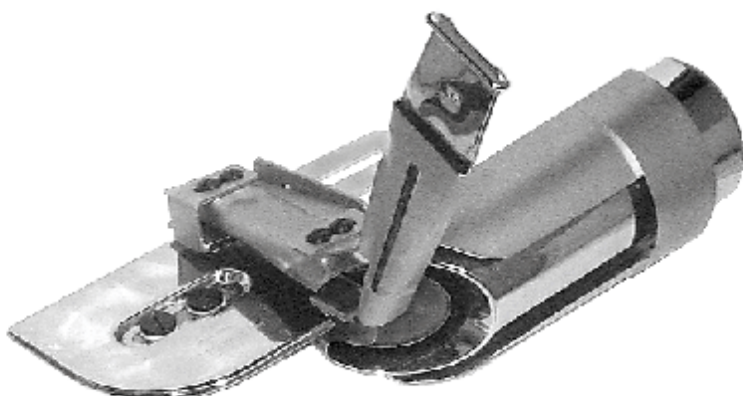

RIGHT ANGLE DOUBLE BINDER
WITH PIPING

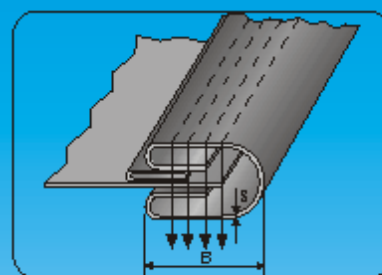

L'APPARECCHIO VIENE FORNITO COMPLETO DI ATTACCO UNIVERSALE

THE ATTACHMENT IS SUPPLIED WITH UNIVERSAL BRACKET

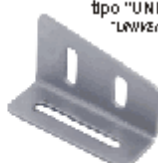

F31002S

tipo "UNIVERSALE"
"UNIVERSAL" type

ATTACCO A RICHIESTA
UPON REQUEST BRACKET

tipo "RIMOLDI"
"RIMOLDI" type



F31002R

Codice	Entrata (A) (tape size) (mm)	Lav. finito (B) (finished size) (mm)	Spessore (S) (thickness)
--------	------------------------------------	--	-----------------------------

L'APPARECCHIO VIENE FORNITO SU RICHIESTA

Con l'ordinazione è necessario che ci siano inviati sia il campione della fettuccia che deve essere utilizzata, sia il campione del materiale che deve essere bordato.

MANUFACTURED ON REQUEST

With the order we need to receive both sample of tape to be used and sample of material to be binded.

F1295 BORDATORE A 3 RISVOLTI CON INSERIMENTO DI ELASTICO

Per macchine a 4 aghi
For 4 needle machines

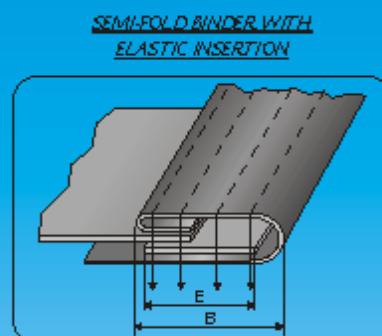
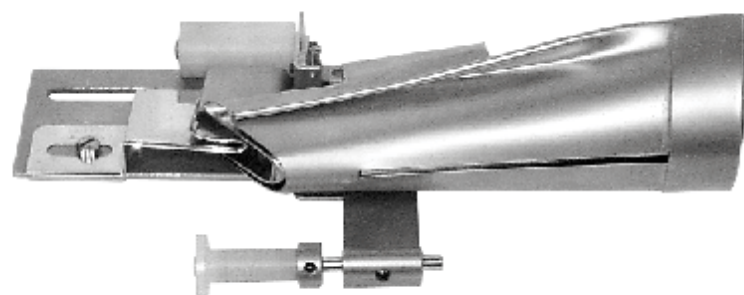

Codice	Entrata (A) (tape size)		Lav. finito (B) (finished size)		Elastico (E) (elastic size)	
	(mm)	(inch)	(mm)	(inch)	(mm)	(inch)
F1295/90E30	90	3-9/16	32	1-1/4	30	1-3/16
F1295/120E40	120	4-25/32	42	1-21/32	40	1-9/16

UN NUOVO METODO PER LA PRODUZIONE DI COSTUMI DA BAGNO CON MUTANDA INTERNA

Sul costume e da bagno viene applicata una fascia e contemporaneamente l'elastico. Si ottiene così, un capo che può avere la fascia di colore e di materiale diverso dal costume. Sul lembo interno si applica poi la mutanda, in modo rapido, con la taglia a cucir.

A NEW PROCESSING TECHNIQUE IN THE MANUFACTURE OF BATHING COSTUMES WITH INSIDE UNDERPANT

On the bathing costume is applied one band and at the same time the elastic. So, we get an item whose color and material band can be different from the one of the bathing costume.

Then on the inside edge is quickly applied the underpant by an overlock machine.

FRENAGGIO CONSIGLIATO
SUGGERITO
TAPE RACK TENSION



F519

F1296 BORDATORE PER CINTURE A 4 RISVOLTI CON INSERIMENTO DI ELASTICO

Per macchine a 4 aghi
For 4 needle machines

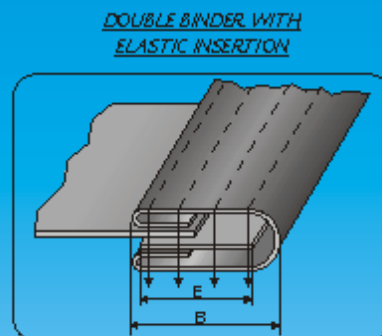
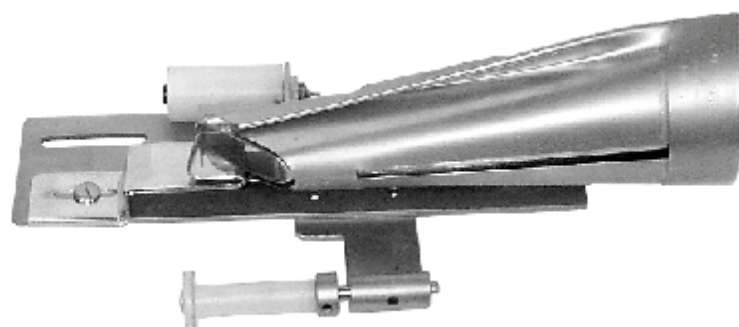

Codice	Entrata (A) (tape size)		Lav. finito (B) (finished size)		Elastico (E) (elastic size)	
	(mm)	(inch)	(mm)	(inch)	(mm)	(inch)
F1296/90E30	90	3-9/16	32	1-1/4	30	1-3/16
F1296/120E40	120	4-25/32	42	1-21/32	40	1-9/16

UN NUOVO METODO PER LA PRODUZIONE DI CINTURE DI PANTALONI

Sul pantalone viene applicata una fascia e contemporaneamente l'elastico. Si ottiene così, un capo che può avere la fascia di colore e di materiale diverso dal pantalone.

A NEW PROCESSING TECHNIQUE IN THE MANUFACTURE OF BATHING COSTUMES WITH INSIDE UNDERPANT

On the shirt is applied one band and at the same time the elastic. So, we get an item whose color and material band can be different from the one of the shirt.

FRENAGGIO CONSIGLIATO
SUGGERITO
TAPE RACK TENSION



F519

F44 BORDATORE PER COLLARETTI PIEGA SEMPLICE

*Per macchine ribattrici
For cover stitch machines*

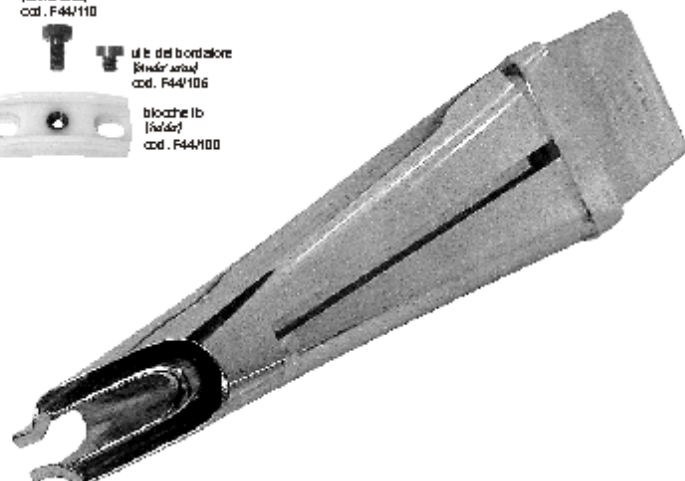

F44B

*con prolunga fissa
with fixed extension*



Mantiene in guida il materiale.
FORNIBILE A RICHIESTA
*Keep material on right guide
AVAILABLE ON REQUEST*

F344

*con linguette regolabili
with adjustable tongue*



Consente di ottenere bordature
perfette utilizzando materiali diversi.
FORNIBILE A RICHIESTA
*Allows to get perfect binding
works with different materials
AVAILABLE ON REQUEST*

F44H BORDATORE PER COLLARETTI PIEGA SEMPLICE - PASSAGGIO ALTO

*Per macchine ribattrici
For cover stitch machines*

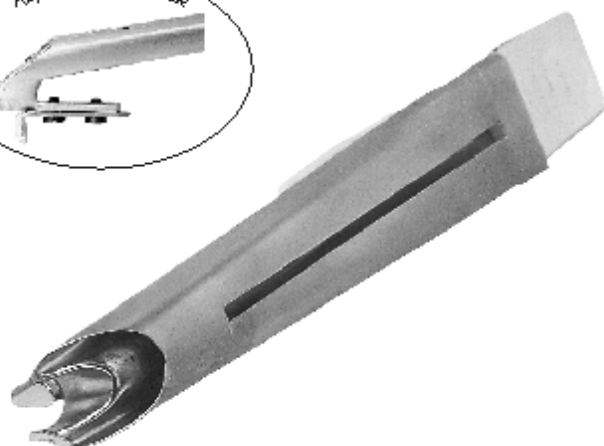

SINGLE COLLARETTE BINDING FOLDER

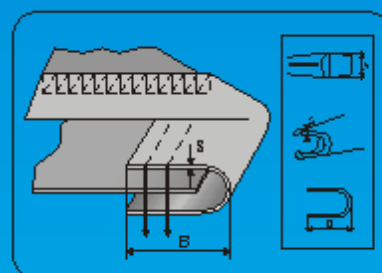

Codice	(A)	(B)	(S)	Codice	(A)	(B)	(S)
F44/10x5 ±1	10	5	1	F44/33 ±19 ±1,5	38	19	1,5
F44/12x6 ±1	12	6	1	F44/33 ±19 ±2	38	19	2
F44/14x7 ±1	14	7	1	F44/33 ±19 ±2,5	38	19	2,5
F44/14x7 ±1,5	14	7	1,5	F44/40 ±20 ±2	40	20	2
F44/15x7,5 ±1	15	7,5	1	F44/40 ±20 ±3	40	20	3
F44/15x7,5 ±1,5	15	7,5	1,5	F44/45 ±22,5 ±2	45	22,5	2
F44/16x8 ±1	16	8	1	F44/45 ±22,5 ±3	45	22,5	3
F44/16x8 ±1,5	16	8	1,5	F44/45 ±24 ±2	45	24	2
F44/16x8 ±2	16	8	2	F44/50 ±25 ±2	50	25	2
F44/18x9 ±1,5	18	9	1,5	F44/51 ±25,5 ±2	51	25,5	2
F44/20 ±10 ±1,5	20	10	1,5	F44/51 ±25,5 ±3	51	25,5	3
F44/22 ±11 ±1,5	22	11	1,5	F44/56 ±28 ±2	51	25,5	3
F44/26 ±13 ±1,5	26	13	1,5	F44/60 ±30 ±2	60	30	2
F44/26 ±13 ±2	26	13	2	F44/60 ±30 ±3	60	30	3
F44/28 ±14 ±1,5	28	14	1,5	F44/70 ±35 ±2	70	35	2
F44/28 ±14 ±2	28	14	2	F44/70 ±35 ±3	70	35	3
F44/30 ±15 ±1,5	30	15	1,5	F44/80 ±40 ±2,5	80	40	2,5
F44/30 ±15 ±2,5	30	15	2,5	F44/80 ±45 ±2,5	80	45	2,5
F44/32 ±16 ±1,5	32	16	1,5	F44/100 ±50 ±2,5	100	50	2,5
F44/32 ±16 ±2,5	32	16	2,5	F44/110 ±55 ±2,5	110	55	2,5
F44/35 ±17,5 ±2	35	17,5	2	F44/120 ±60 ±2,5	120	60	2,5
F44/35 ±17,5 ±3	35	17,5	3	F44/130 ±65 ±2,5	130	65	2,5
F44/36 ±18 ±2	36	18	2				

SINGLE COLLARETTE BINDING FOLDER - FOR THICK MATERIAL

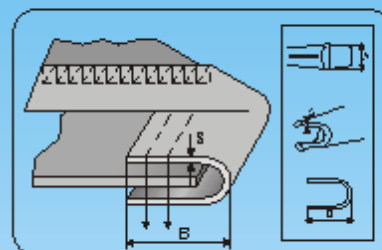

Codice	Entrata (A) (tape size) (mm) (inch)	Lav. finito (B) (finished size) (mm) (inch)	Spessore (S) (thickness) (mm) (inch)
F44H/18x9x3	18 23,02	9 23,64	3 1/8
F44H/20x10x3	20 25,02	10 25,64	3 1/8
F44H/26x13x3	26 1-1/32	13 33,64	3 1/8
F44H/28x14x3	28 1-1/8	14 9/16	3 1/8
F44H/30x15x4	30 1-3/16	15 19,02	4 5/32
F44H/32x16x4	32 1-1/4	16 5,8	4 5/32
F44H/35x17,5x4	35 1-3/8	17,5 11/16	4 5/32
F44H/40x20x4	40 1-9/16	20 25,02	4 5/32
F44H/50x25x4	50 2	25 1	4 5/32
F44H/60x30x4	60 2-3/8	30 1-3/16	4 5/32
F44H/70x35x4	70 2-3/4	35 1-3/8	4 5/32
F44H/80x40x4	80 3-3/16	40 1-9/16	4 5/32
F44H/90x45x4	90 3-9/16	45 1-3/4	4 5/32
F44H/100x50x4	100 4	50 2	4 5/32

F43 BORDATORE PER COLLARETTI A 3 RISVOLTI BORDI PARI

Per macchine ribattrici
For cover stitch machines

vitte centrate
(screws/axial)
cod. F44110

vitte del bordatore
(screws/axial)
cod. F44106

bloccello
bracket
cod. F44100

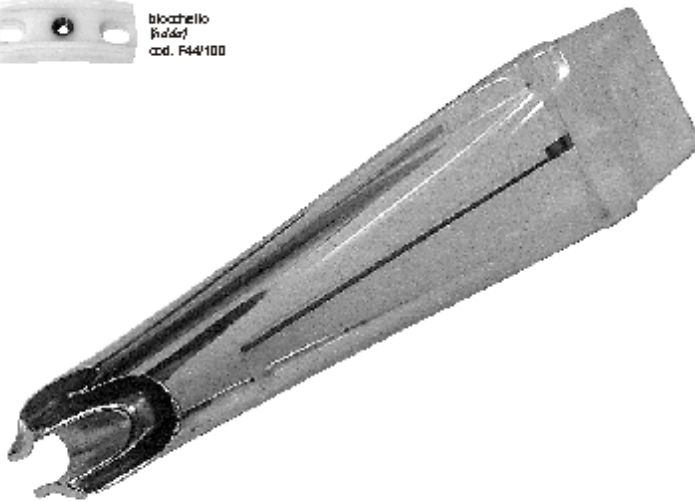

COLLARETTE BINDING FOLDER THREE FOLD

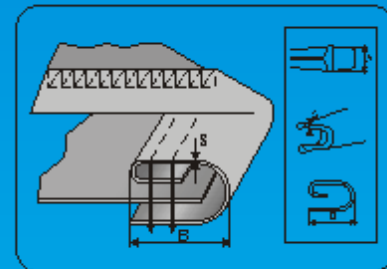

Codice	Entrata (A) (tape size) (in) (out)		Lav. finito (B) (finished size) (in) (out)		Spessore (S) (thickness) (in) (out)	
	(in)	(out)	(in)	(out)	(in)	(out)
F43/22x8x1,5	22	7/8	8	5/16	1,5	1/16
F43/25x8x2,5	25	1	8	5/16	2,5	3/32
F43/25x9x1,3	25	1	9	23/64	1,3	3/64
F43/27x10x1,5	27	1-1/16	10	3/8	1,5	1/16
F43/28x10x1,6	28	1-1/8	10	3/8	1,6	1/16
F43/33x12,5x1,7	33	1-19/64	12,5	1/2	1,7	1/16
F43/33x12,5x2,7	33	1-19/64	12,5	1/2	2,7	7/64
F43/35x14x1,7	35	1-3/8	14	9/16	1,7	1/16
F43/40x16x1,7	40	1-9/16	16	5/8	1,7	1/16
F43/40x16x2,7	40	1-9/16	16	5/8	2,7	7/64
F43/46x19x2	46	1-13/16	19	3/4	2	5/64
F43/46x19x3	46	1-13/16	19	3/4	3	1/8
F43/52x22x2	52	2-3/64	22	7/8	2	5/64
F43/52x22x3	52	2-3/64	22	7/8	3	1/8
F43/59x25x3,2	59	2-21/64	25	1	3,2	1/8
F43/59x25,5x2	59	2-21/64	25,5	1	2	5/64
F43/72x31x3	72	2-27/64	31	1-1/4	3	1/8
F43/72x32x2	72	2-27/64	32	1-1/4	2	5/64
F43/82x36x3	82	3-1/4	36	1-7/16	3	1/8
F43/82x37x2	82	3-1/4	37	1-31/64	2	5/64
F43/103x47x3	103	4-1/16	47	1-27/32	3	1/8
F43/123x57x3	123	4-27/64	57	2-1/4	3	1/8
F43/133x62x3	133	5-1/4	62	2-7/16	3	1/8

F43B con prolunga fissa with fixed extension



Mantiene in guida il materiale.
FORNIBILE A RICHIESTA

Keep material on right guide
AVAILABLE ON REQUEST

COLLARETTE BINDING FOLDER
THREE FOLD - FOR THICK MATERIAL

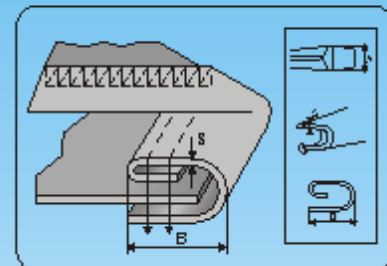

F43H BORDATORE PER COLLARETTI A 3 RISVOLTI BORDI PARI - PASSAGGIO ALTO

Per macchine ribattrici
For cover stitch machines

SPINGITORE REGOLABILE
ADJUSTABLE PUSHER

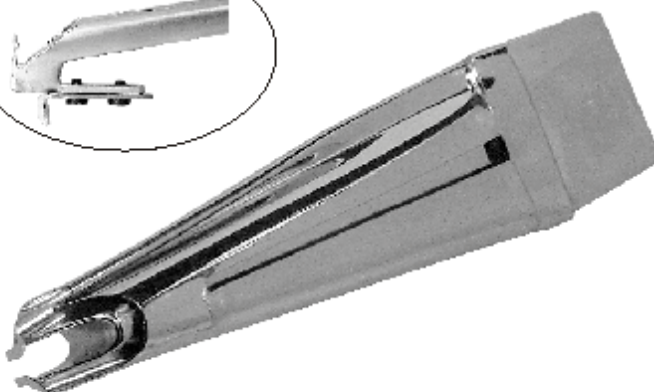

Codice	Entrata (A) (tape size) (in) (out)		Lav. finito (B) (finished size) (in) (out)		Spessore (S) (thickness) (in) (out)	
	(in)	(out)	(in)	(out)	(in)	(out)
F43H/36x13x3	36	1-7/16	13	33/64	3	1/8
F43H/40x15x3	40	1-9/16	15	19/32	3	1/8
F43H/45x17x4	45	1-3/4	17	21/32	4	5/32
F43H/50x19x4	50	2	19	3/4	4	5/32
F43H/55x22x4	55	2-3/16	22	7/8	4	5/32
F43H/60x24x4	60	2-3/8	24	15/16	4	5/32
F43H/65x27x4	65	2-19/32	27	1-1/16	4	5/32
F43H/70x29x4	70	2-3/4	29	1-9/64	4	5/32

F42 BORDATORE PER COLLARETTA 3 RISVOLTI BORDI SFALSATI

utile centrale
(central anvil)
cod. F44110



utile del bordatore
(folder anvil)
cod. F44106

bloccare lb
(holder)
cod. F44100

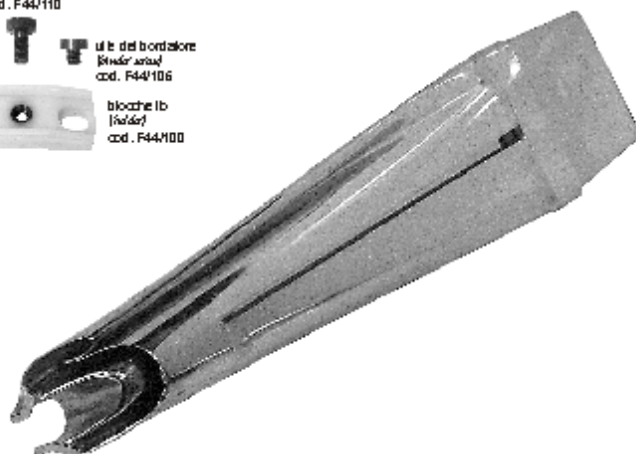

Per macchine ribattrici
For cover stitch machines

F42B

con prolunga fissa
with fixed extension



Mantiene in guida il materiale.
FORNIBILE A RICHIESTA
Keep material on right guide
AVAILABLE ON REQUEST

F342

con linguette regolabili
with adjustable tongue



Consente di ottenere bordature
perfette utilizzando materiali diversi.
FORNIBILE A RICHIESTA
Allows to get perfect binding
works with different materials
AVAILABLE ON REQUEST

F42H BORDATORE PER COLLARETTI A 3 RISVOLTI BORDI SFALSATI - PASSAGGIO ALTO

Per macchine ribattrici
For cover stitch machines

SPINTORE REGOLABILE
ADJUSTABLE PUSHER

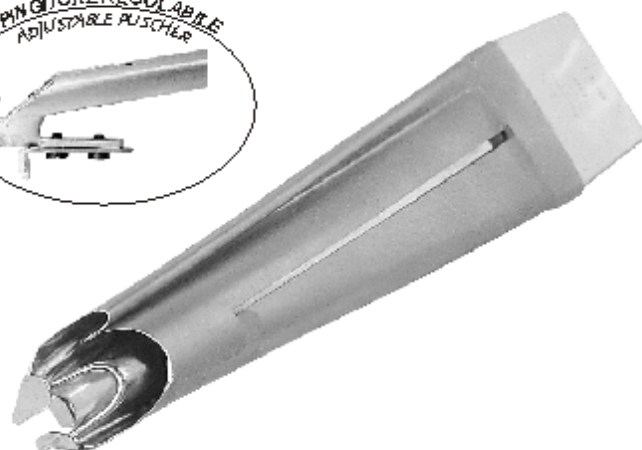

SINGLE COLLARETTA BINDING FOLDER

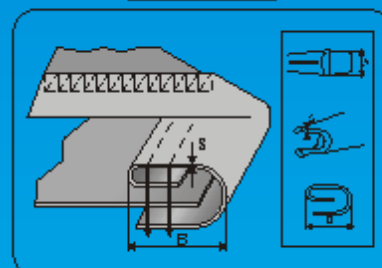

Codice				Codice			
	(A)	(B)	(S)		(A)	(B)	(S)
F42001511	20	5	1	F420512412	55	24	2
F420217,511,2	22	7,5	1,2	F4205712413	57	24	3
F42051911,3	25	9	1,3	F4205712512	57	25	2
F420711011,3	27	10	1,3	F42059125,512	59	25,5	2
F420711012	27	10	2	F4206012612	60	26	2
F4200111,511,5	30	11,5	1,5	F4206512812	65	28	2
F4202112,511,7	32	12,5	1,7	F4207013013	70	30	3
F4202112,512,5	32	12,5	2,5	F4207013112	70	31	2
F420511411,7	35	14	1,7	F4207213212	72	32	2
F420511412,5	35	14	2,5	F4208013513	80	35	3
F4208115,511,7	38	15,5	1,7	F4208013612	80	36	2
F420811512,7	38	15	2,7	F4209014013	90	40	3
F4200116,512	40	16,5	2	F4209014112	90	41	2
F4202117,512	42	17,5	2	F4210014612	100	46	2
F420511813	45	18	3	F4210014613	100	46	3
F420511912	45	19	2	F4211015012	110	50	2
F420711913	47	19	3	F4211015013	110	50	3
F420712012	47	20	2	F4212015513	120	55	3
F4205112113	51	21	3	F4213016013	130	60	3
F4205112212	51	22	2				

SINGLE COLLARETTA BINDING FOLDER - FOR THICK MATERIAL

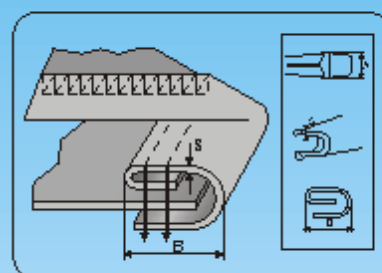

Codice	Entrata (A) (tape size) (mm) (inch)		Lav. finito (B) (finished size) (mm) (inch)		Spessore (S) (thickness) (mm) (inch)	
	F42H/32x11x3	32	1-1/4	11	7/16	3
F42H/36x13x3	36	1-7/16	13	33/64	3	1/8
F42H/40x15x3	40	1-9/16	15	19/32	3	1/8
F42H/45x17x4	45	1-3/4	17	21/32	4	5/32
F42H/50x19x4	50	2	19	3/4	4	5/32
F42H/55x22x4	55	2-3/16	22	7/8	4	5/32
F42H/60x24x4	60	2-3/8	24	15/16	4	5/32
F42H/65x27x4	65	2-19/32	27	1-1/16	4	5/32
F42H/70x29x4	70	2-3/4	29	1-9/64	4	5/32

F40 BORDATORE PER COLLARETTI DOPPIA PIEGA

Per macchine ribattrici
For cover stitch machines

fillo centrale
(cover/central)
cod. F44110

fillo del bordatore
(border/cover)
cod. F44106

bloccetto
(bracket)
cod. F44100

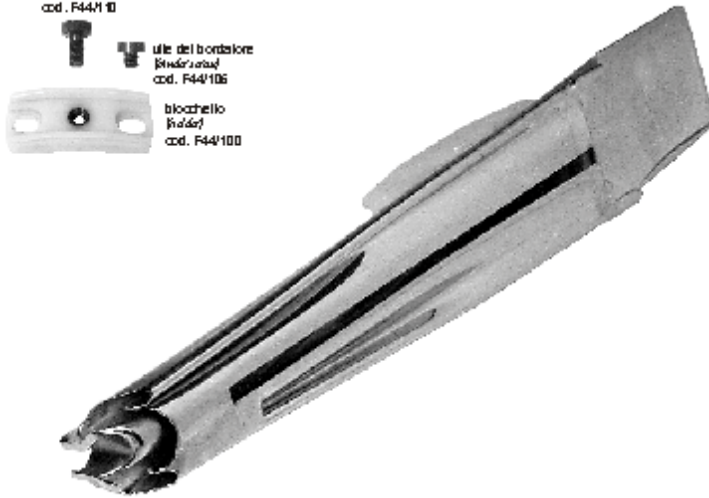

DOUBLE COLLARETTE BINDING FOLDER

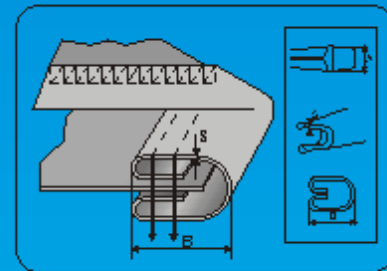

Codice	(A)	(B)	(S)	Codice	(A)	(B)	(S)
F40/18 x4,5x1	18	4,5	1	F40/50 x18 x2	50	18	2
F40/20 x5 x1	20	5	1	F40/56 x21 x2	56	21	2
F40/22 x5,5x1,2	22	5,5	1,2	F40/60 x20 x3	60	20	3
F40/22 x5,5x2	22	5,5	2	F40/60 x22 x2	60	22	2
F40/25 x6 x1,2	25	6	1,2	F40/66 x24 x3	66	24	3
F40/25 x6 x2	25	6	2	F40/66 x26 x2	66	26	2
F40/28 x7 x1,3	28	7	1,3	F40/70 x28 x2	70	28	2
F40/28 x7 x2	28	7	2	F40/75 x29 x2	75	29	2
F40/28 x7 x2,5	28	7	2,5	F40/78 x31 x1,5	78	31	1,5
F40/30 x8 x1,5	30	8	1,5	F40/78 x31 x2	78	31	2
F40/30 x8 x2	30	8	2	F40/80 x30 x3	80	30	3
F40/30 x8 x2,5	30	8	2,5	F40/80 x32 x2	80	32	2
F40/32 x9 x1,5	32	9	1,5	F40/86 x34 x3	86	34	3
F40/32 x9 x2,5	32	9	2,5	F40/86 x36 x2	86	36	2
F40/35 x10 x1,5	35	10	1,5	F40/90 x37 x2	90	37	2
F40/35 x10 x2,5	35	10	2,5	F40/92 x38 x2	92	38	2
F40/38 x12 x1,7	38	12	1,7	F40/96 x40 x2	96	40	2
F40/38 x12 x2,5	38	12	2,5	F40/100 x40 x3	100	40	3
F40/40 x13 x2	40	13	2	F40/100 x42 x2	100	42	2
F40/42 x14 x2	42	14	2	F40/110 x47 x2	110	47	2
F40/44 x15 x2	44	15	2	F40/120 x50 x2,5	120	50	2,5
F40/46 x16 x2	46	16	2	F40/130 x55 x2,5	130	55	2,5
F40/48 x17 x2	48	17	2				

F40B

con prolunga fissa
with fixed extension



Mantiene in guida il materiale.
FORNIBILE A RICHIESTA
Keep material on right guide
AVAILABLE ON REQUEST

F340

con linguette regolabili
with adjustable tongue



Consente di ottenere bordature
perfette utilizzando materiali diversi.
FORNIBILE A RICHIESTA
Allows to get perfect binding
works with different materials
AVAILABLE ON REQUEST

DOUBLE COLLARETTE BINDING FOLDER - FOR THICK MATERIAL

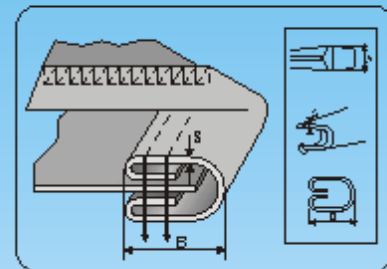

Codice	Entrata (A) (tape size) (in mm)	Lav. finito (B) (finished size) (in cm)	Spessore (S) (thickness) (in mm)
F40H/32x8x3	32 1-1/4	8 5/16	3 1/8
F40H/35x10x3	35 1-3/8	10 25/64	3 1/8
F40H/38x11x3,5	38 1-1/2	11 7/16	3,5 9/64
F40H/40x13x3,5	40 1-9/16	13 33/64	3,5 9/64
F40H/45x14x3,5	45 1-3/4	14 9/16	3,5 9/64
F40H/50x16x3,5	50 2	16 5/8	3,5 9/64
F40H/55x18x4	55 2-3/16	18 23/32	4 5/32
F40H/60x20x4	60 2-3/8	20 25/32	4 5/32
F40H/70x25x4	70 2-3/4	25 1	4 5/32

F40H BORDATORE PER COLLARETTI DOPPIA PIEGA - PASSAGGIO ALTO

Per macchine ribattrici
For cover stitch machines

SPINGITORE REGOLABILE
ADJUSTABLE PUSHER

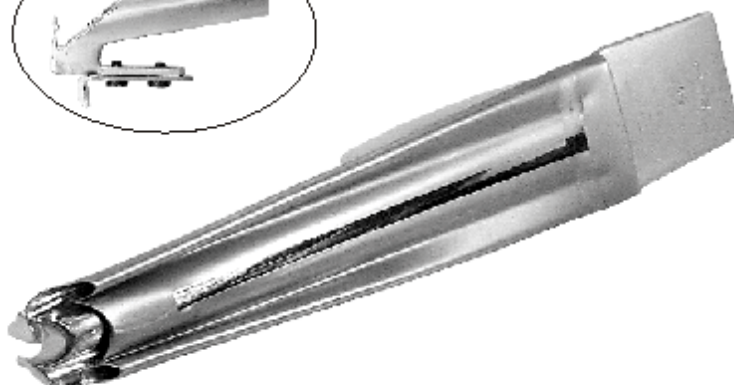

F601 BORDATORE TIPO COLLARETTO PIEGA SEMPLICE

Per macchine piane
For flat bed machines

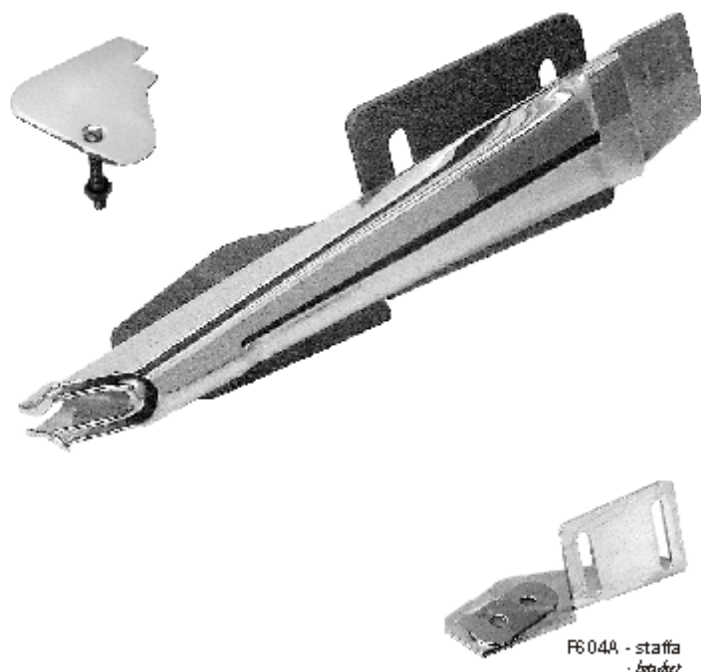

*SINGLE COLLARETTE BINDING FOLDER
FOR FLAT BED MACHINES*

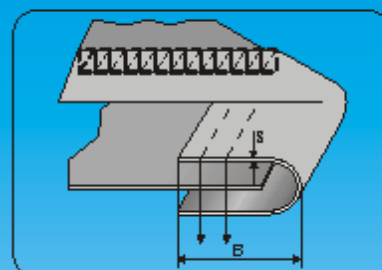

Codice	(A)	(B)	(S)	Codice	(A)	(B)	(S)
F601/15x7,5x1	15	7,5	1	F601/50x25x3	50	25	3
F601/20x10x1,5	20	10	1,5	F601/56x28x2	56	28	2
F601/25x12x1,5	25	12	1,5	F601/60x30x2	60	30	2
F601/28x14x1,5	28	14	1,5	F601/60x30x3	60	30	3
F601/30x15x1,5	30	15	1,5	F601/64x32x2	64	32	2
F601/32x16x1,5	32	16	1,5	F601/64x32x3	64	32	3
F601/35x17x2	35	17	2				
F601/38x19x2	38	19	2				
F601/38x19x3	38	19	3				
F601/40x20x2	40	20	2				
F601/40x20x3	40	20	3				
F601/45x22x2	45	22	2				
F601/45x22x3	45	22	3				
F601/48x24x2	48	24	2				
F601/50x25x2	50	25	2				

F602 BORDATORE TIPO COLLARETTO A 3 RISVOLTI SFALSATI

Per macchine piane
For flat bed machines

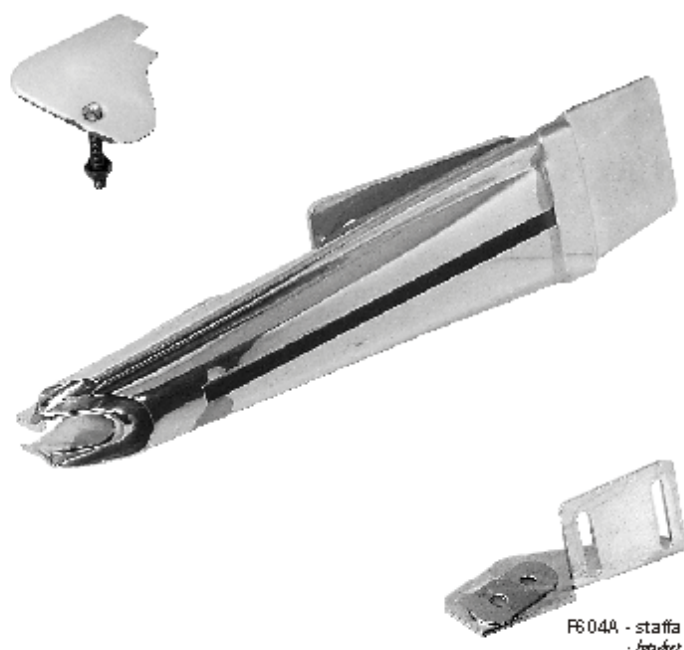

*COLLARETTE BINDING FOLDER
FOR FLAT BED MACHINES - THREE FOLD*

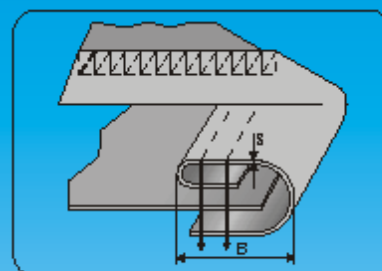

Codice	(A)	(B)	(S)	Codice	(A)	(B)	(S)
F602/22x7,5x1,2	22	7,5	1,2	F602/51x22x2	51	22	2
F602/25x9x1,3	25	9	1,3	F602/51x21x3	51	21	3
F602/27x10x1,3	27	10	1,3	F602/55x24x2	55	24	2
F602/27x10x2	27	10	2	F602/57x25x2	57	25	2
F602/30x11,5x1,5	30	11,5	1,5	F602/57x24x3	57	24	3
F602/32x12,5x1,7	32	12,5	1,7				
F602/35x14x1,7	35	14	1,7				
F602/35x14x2,5	35	14	2,5				
F602/38x15,5x1,7	38	15,5	1,7				
F602/38x15x2,7	38	15	2,7				
F602/40x16,5x2	40	16,5	2				
F602/45x19x2	45	19	2				
F602/45x18x3	45	18	3				
F602/47x20x2	47	20	2				
F602/47x19x3	47	19	3				

F603 BORDATORE TIPO COLLARETTO A 3 RISVOLTI PARI

Per macchine piane
For flat bed machines

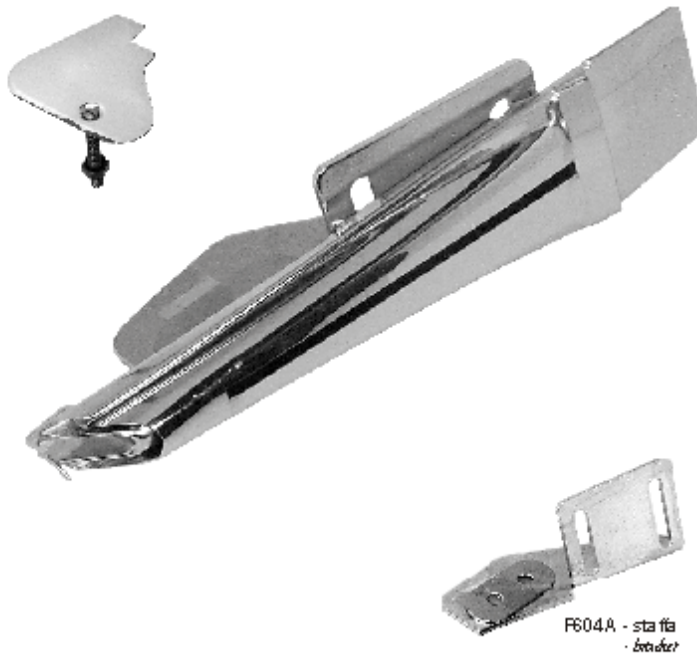

*COLLARETTE BINDING FOLDER
FOR FLAT BED MACHINES - THREE FOLD*

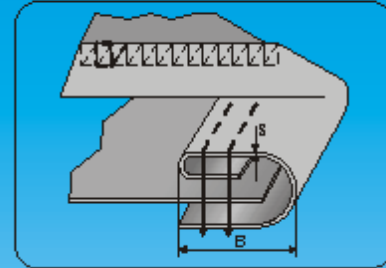

Codice	Entrata (A) (tape size)		Lav. finito (B) (finished size)		Spessore (S) (thickness)	
	(mm)	(inch)	(mm)	(inch)	(mm)	(inch)
F603/22x8x1,2	22	7/8	8	5/16	1,2	3,64
F603/25x9x1,3	25	1	9	23/64	1,3	3,64
F603/27x10x1,5	27	1-1/16	10	25/64	1,5	1/16
F603/33x12,5x1,7	33	1-19/64	12,5	1/2	1,7	1/16
F603/33x12,5x2,7	33	1-19/64	12,5	1/2	2,7	7,64
F603/40x16x1,7	40	1-9/16	16	5/8	1,7	1/16
F603/40x16x2,7	40	1-9/16	16	3/4	2,7	7,64
F603/46x19x2	46	1-13/16	19	3/4	2	5,64
F603/46x19x2	46	1-13/16	19	3/4	3	1/8
F603/52x22x2	52	2-3/64	22	7/8	2	5,64
F603/52x22x2	52	2-3/64	22	7/8	3	1/8
F603/59x25x2	59	2-21/64	25	1	2	5,64
F603/59x25x3	59	2-21/64	25	1	3	1/8

F604 BORDATORE TIPO COLLARETTO DOPPIA PIEGA

Per macchine piane
For flat bed machines

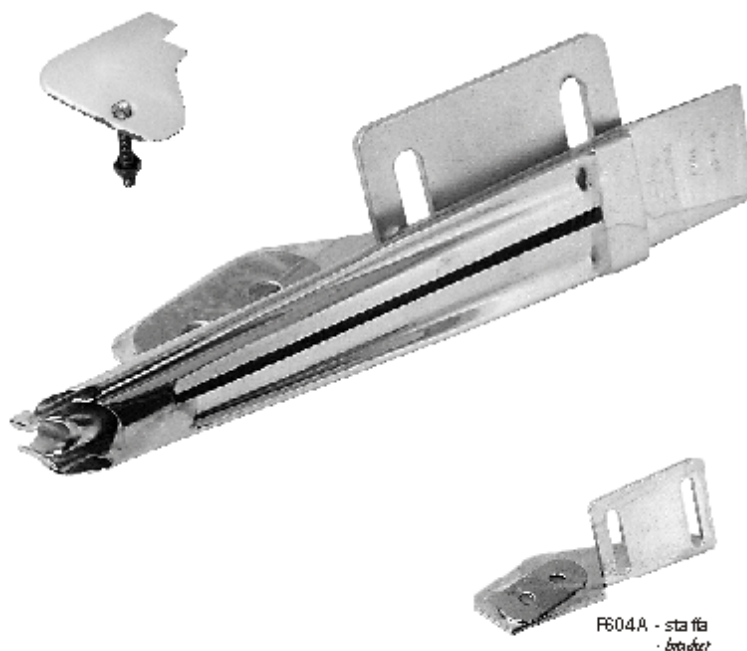

*DOUBLE COLLARETTE BINDING FOLDER
FOR FLAT BED MACHINES*

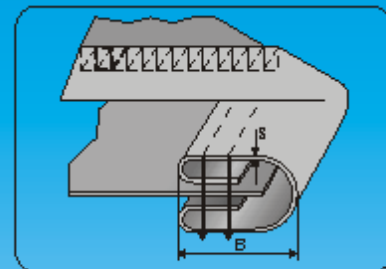

Codice	Entrata (A) (tape size)		Lav. finito (B) (finished size)		Spessore (S) (thickness)	
	(mm)	(inch)	(mm)	(inch)	(mm)	(inch)
F604/22x5,5x1	22	7/8	5,5	7/32	1	3,64
F604/22x5,5x2	22	7/8	5,5	7/32	2	5,64
F604/25x6x2	25	1	6	1/4	2	5,64
F604/28x7x2	28	1-1/8	7	9/32	2	5,64
F604/32x8x1,5	32	1-1/4	8	5/16	1,5	1/16
F604/35x10x2	35	1-3/8	10	3/8	2	5,64
F604/38x12x2	38	1-1/2	12	31/64	2	5,64
F604/42x14x2	42	1-21/32	14	9/16	2	5,64
F604/46x16x2	46	1-13/16	16	5/8	2	5,64
F604/56x21x2,5	56	2-13/64	21	13/16	2,5	3,02
F604/65x25x2	65	2-19/32	25	1	2	5,64
F604/66x26x3,5	66	2-5/8	26	1-1/32	3,5	9,64

F265 BORDATORE PER COLLARETTI DOPPIA PIEGA CON INSERIMENTO ELASTICO NEL RISVOLTO SUPERIORE

*Per macchine ribattrici
For cover-stitch machines*

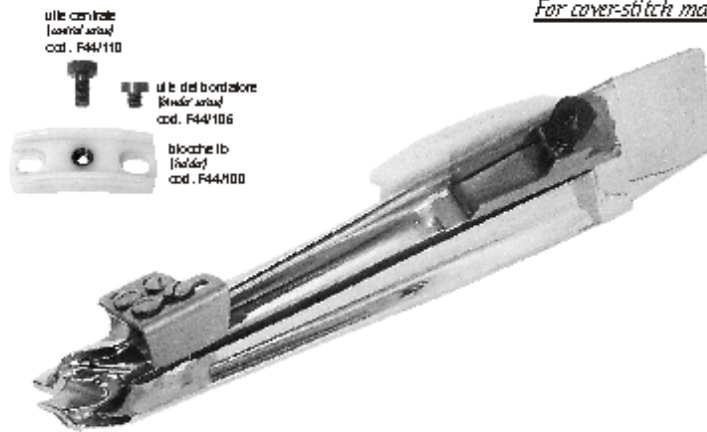

F269
con spingitore regolabile
with adjustable pusher



Mantiene in guida il materiale.
FORNIBILE A RICHIESTA
Keep material on right guide
AVAILABLE ON REQUEST

*DOUBLE COLLARETTE BINDING FOLDER WITH
ELASTIC INSERTION IN THE UPPER EDGE*

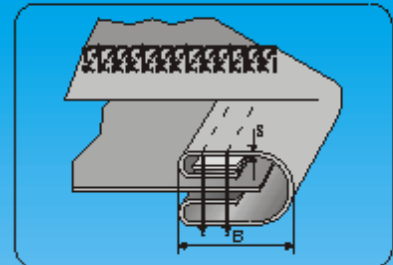

Codice	Entrata (A) (tape size) (mm)	Lav. finito (B) (finished size) (mm)	Spessore (S) (thickness)
--------	------------------------------------	--	-----------------------------

I BORDATORI VENGONO FORNITI SU RICHIESTA

Con l'ordinazione è necessario che ci siano inviati:
- il campione della fettuccia che deve essere utilizzata,
- il campione del materiale da inserire come rinforzo,
- il campione del materiale che deve essere bordato.

MANUFACTURED ON REQUEST

*With the order we need to receive both sample of rope to be used,
sample of reinforcement and sample of material to be bound.*

F46 - 46B - 47 - 47B - 48 - 48B - 49

utile centrale
(central utility)
cod. F44/10



utile del bordatore
(border utility)
cod. F44/106

bloccetto
(folder)
cod. F44/100

Per macchine ribattrici
For cover-stitch machines

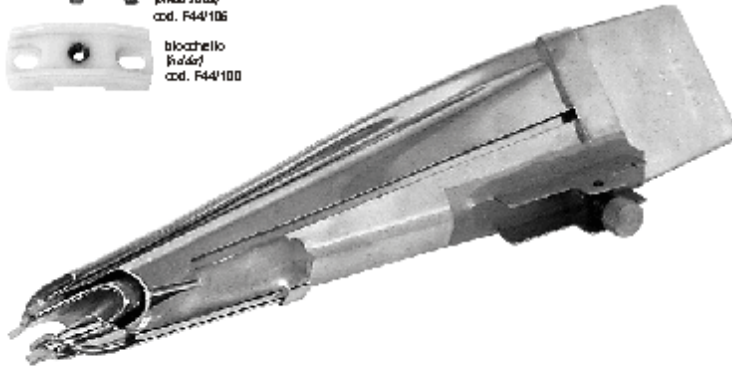

Codice	Entrata (A) (tape size) (mm)	Lav. finito (B) (finished size) (mm)	Spessore (S) (thickness)
--------	------------------------------------	--	-----------------------------

I BORDATORI VENGONO FORNITI SU RICHIESTA

Con l'ordinazione è necessario che ci siano inviati:
- il campione della fettuccia che deve essere utilizzata,
- il campione del materiale da inserire come rinforzo,
- il campione del materiale che deve essere bordato.

MANUFACTURED ON REQUEST

*With the order we need to receive both sample of tape to be used,
sample of reinforcement and sample of material to be bonded.*

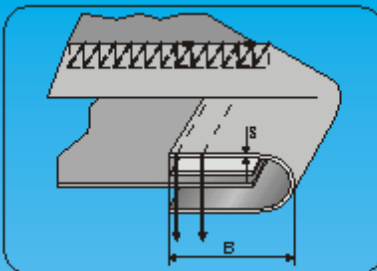

F46

BORDATORE PER
COLLA RETTI
PIEGA SEMPLICE
CON INSERIMENTO
DI ELASTICO SOPRA

SINGLE COLLARETTE
BINDING FOLDER WITH
ELASTIC OVER MATERIAL

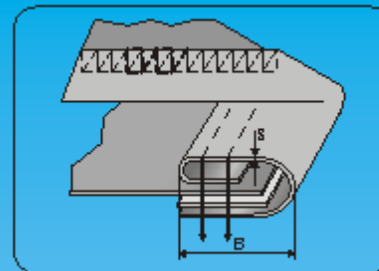

F48

BORDATORE PER
COLLA RETTI A 3
RISVOLTI PARI
CON INSERIMENTO
DI ELASTICO SOTTO

SEMI-FOLD COLLARETTE
BINDING FOLDER WITH
ELASTIC UNDER MATERIAL

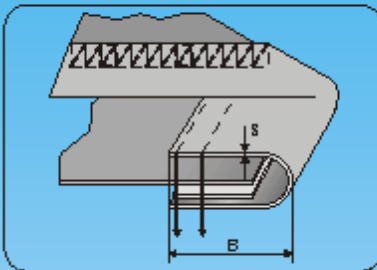

F46B

BORDATORE PER
COLLA RETTI
PIEGA SEMPLICE
CON INSERIMENTO
DI ELASTICO SOTTO

SINGLE COLLARETTE
BINDING FOLDER WITH
ELASTIC UNDER MATERIAL

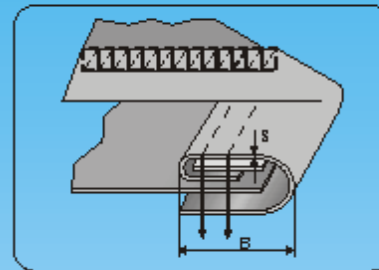

F48B

BORDATORE PER
COLLA RETTI A 3
RISVOLTI PARI
CON INSERIMENTO DI
ELASTICO NEL RISVOLTO

SEMI-FOLD COLLARETTE
BINDING FOLDER WITH
ELASTIC IN THE EDGE

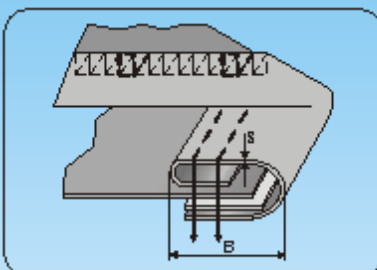

F47

BORDATORE PER
COLLA RETTI A 3
RISVOLTI SFALSA TI
CON INSERIMENTO DI
ELASTICO SOTTO

SEMI-FOLD STAGGER
COLLA RETTE BINDING
FOLDER WITH
ELASTIC UNDER MATERIAL

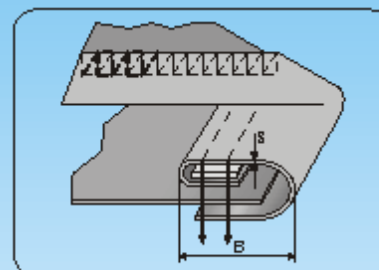

F49

BORDATORE PER
COLLA RETTI A 3
RISVOLTI SFALSA TI
CON INSERIMENTO DI
ELASTICO NEL RISVOLTO

SEMI-FOLD STAGGER
COLLA RETTE BINDING
FOLDER WITH
ELASTIC IN THE EDGE

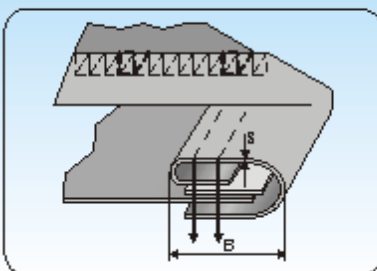

F47B

BORDATORE PER
COLLA RETTI A 3
RISVOLTI SFALSA TI
CON INSERIMENTO DI
ELASTICO SOPRA

SEMI-FOLD STAGGER
COLLA RETTE BINDING
FOLDER WITH
ELASTIC OVER MATERIAL

F274 BORDATORE PER COLLARETTI FINTO RIMAGLIO PIEGA SEMPLICE

*Per "RIMOLDI" 264-16, "EXACTA" e similari
For "RIMOLDI" 264-16, "EXACTA" and similar*

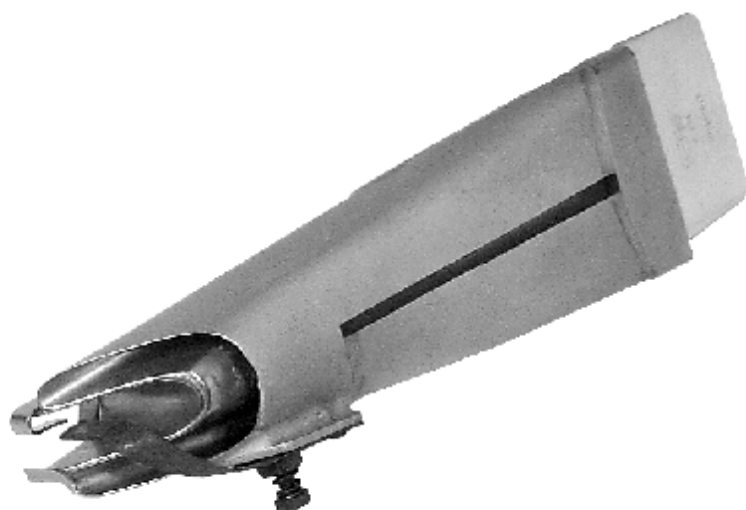

LINKING SPLIT TUBE
FOLDER - SINGLE

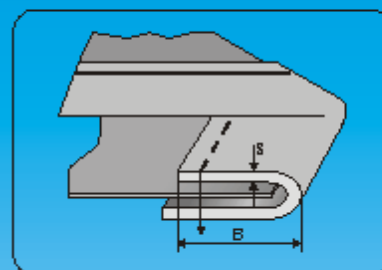

Codice	(A)	(B)	(S)	Codice	(A)	(B)	(S)
F274/20	20	10	4	F274/95	95	47	6
F274/25	25	12	4	F274/100	100	50	6
F274/30	30	15	5	F274/105	105	52	6
F274/35	35	17	5	F274/110	110	55	6
F274/40	40	20	5	F274/120	120	60	6
F274/45	45	22	6	F274/130	130	65	6
F274/50	50	25	6	F274/140	140	70	6
F274/55	55	27	6	F274/150	150	75	6
F274/60	60	30	6	F274/160	160	80	6
F274/65	65	32	6	F274/170	170	85	6
F274/70	70	35	6	F274/180	180	90	6
F274/75	75	37	6				
F274/80	80	40	6				
F274/85	85	42	6				
F274/90	90	45	6				

F272 BORDATORE PER COLLARETTI FINTO RIMAGLIO A 3 RISVOLI

*Per "RIMOLDI" 264-16, "EXACTA" e similari
For "RIMOLDI" 264-16, "EXACTA" and similar*



LINKING SPLIT TUBE
FOLDER - THREE FOLD

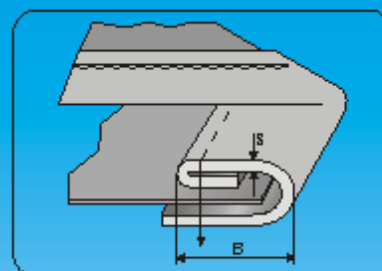

Codice	(A)	(B)	(S)	Codice	(A)	(B)	(S)
F272/30	30	10	3	F272/130	130	57	6
F272/36	36	12	4	F272/140	140	62	6
F272/40	40	13	4	F272/150	150	67	6
F272/45	45	15	4	F272/160	160	72	6
F272/50	50	18	5	F272/170	170	77	6
F272/55	55	20	5	F272/180	180	82	6
F272/60	60	22	5				
F272/65	65	25	5				
F272/70	70	28	5				
F272/75	75	30	5				
F272/80	80	32	5				
F272/85	85	35	5				
F272/100	100	42	5				
F272/110	110	47	5				
F272/120	120	52	6				

F1135

RIBATTITORE

Per macchine piane a 2 o 3 aghi
For 2 or 3 needle flat bed machines

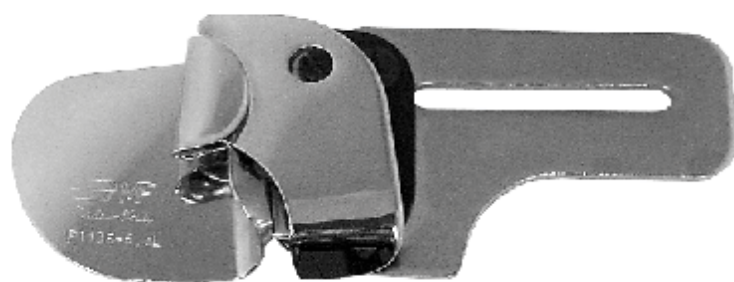

LAP SEAM FOLDER

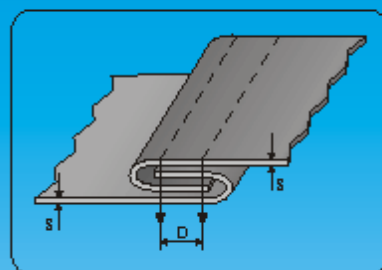

Codice	Dist. aghi (D) (gauge size) (mm) (inch)	Spessore (S) (thickness)	
F1135/4,8L	4,8 3/16	L	
F1135/4,8M	4,8 3/16	M	
F1135/4,8MH	4,8 3/16	MH	
F1135/4,8H	4,8 3/16	H	
F1135/6,4L	6,4 1/4	L	
F1135/6,4M	6,4 1/4	M	
F1135/6,4MH	6,4 1/4	MH	
F1135/6,4H	6,4 1/4	H	
F1135/6,4XH	6,4 1/4	XH	
F1135/8,0L	8,0 5/16	L	
F1135/8,0M	8,0 5/16	M	
F1135/8,0MH	8,0 5/16	MH	
F1135/8,0H	8,0 5/16	H	

F490361

RIBATTITORE

Per "SINGER" 112W, 212W, ecc.
For "SINGER" 112W, 212W, ecc.

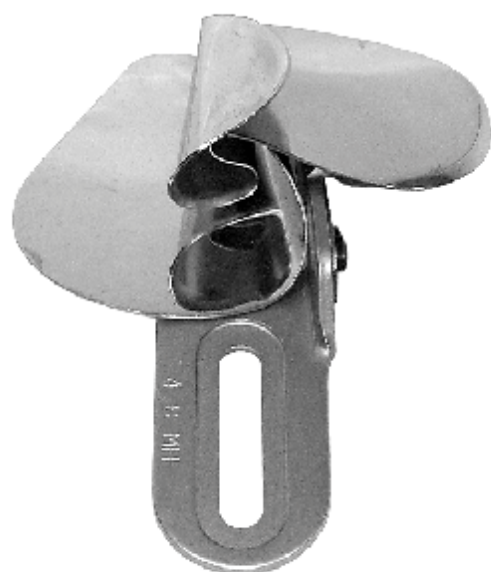

LAP SEAM FOLDER

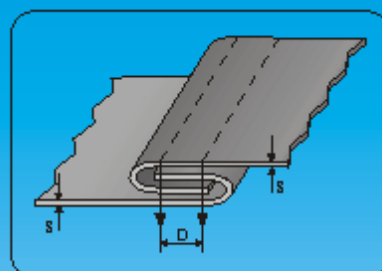

Codice	Dist. aghi (D) (gauge size) (mm) (inch)	Spessore (S) (thickness)	
F490361/4,8L	4,8 3/16	L	
F490361/4,8M	4,8 3/16	M	
F490361/4,8MH	4,8 3/16	MH	
F490361/4,8H	4,8 3/16	H	
F490361/6,4L	6,4 1/4	L	
F490361/6,4M	6,4 1/4	M	
F490361/6,4MH	6,4 1/4	MH	
F490361/6,4H	6,4 1/4	H	
F490361/6,4XH	6,4 1/4	XH	
F490361/8,0L	8,0 5/16	L	
F490361/8,0M	8,0 5/16	M	
F490361/8,0MH	8,0 5/16	MH	
F490361/8,0H	8,0 5/16	H	
F490361/8,0XH	8,0 5/16	XH	

F121586

RIBATTITORE

Per "SINGER" 231, 261, ecc.

For "SINGER" 231, 261, ecc.

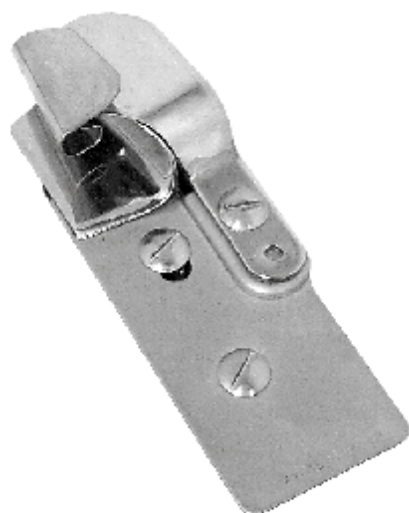

F121586/S - slitta larga (large slide)
F121586/V - vite (screw)

LAP SEAM FOLDER

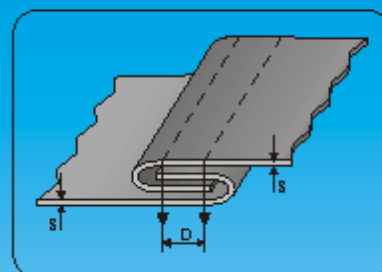

Codice	Dist. aghi (D) gauge size (mm) (inch)	Spessore (S) (thickness)	
F 121586/4,8L	4,8 3/16	L	
F 121586/4,8M	4,8 3/16	M	
F 121586/4,8MH	4,8 3/16	MH	
F 121586/4,8H	4,8 3/16	H	
F 121586/6,4L	6,4 1/4	L	
F 121586/6,4M	6,4 1/4	M	
F 121586/6,4MH	6,4 1/4	MH	
F 121586/6,4H	6,4 1/4	H	
F 121586/6,4XH	6,4 1/4	XH	
F 121586/8,0L	8,0 5/16	L	
F 121586/8,0M	8,0 5/16	M	
F 121586/8,0MH	8,0 5/16	MH	
F 121586/8,0H	8,0 5/16	H	
F 121586/8,0XH	8,0 5/16	XH	

F121757

RIBATTITORE

Per "SINGER" 231-25, ecc.

For "SINGER" 231-25, ecc.

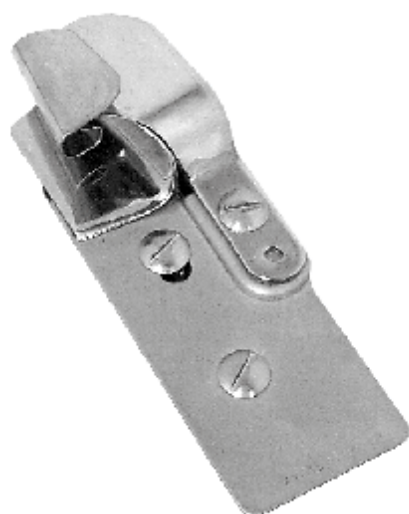

F121757/S - slitta stretta (narrow slide)
F121586/V - vite (screw)

LAP SEAM FOLDER

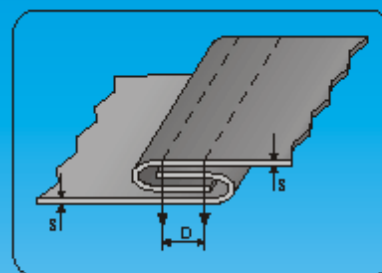

Codice	Dist. aghi (D) gauge size (mm) (inch)	Spessore (S) (thickness)	
F 121757/4,8L	4,8 3/16	L	
F 121757/4,8M	4,8 3/16	M	
F 121757/4,8MH	4,8 3/16	MH	
F 121757/4,8H	4,8 3/16	H	
F 121757/6,4L	6,4 1/4	L	
F 121757/6,4M	6,4 1/4	M	
F 121757/6,4MH	6,4 1/4	MH	
F 121757/6,4H	6,4 1/4	H	
F 121757/6,4XH	6,4 1/4	XH	
F 121757/8,0L	8,0 5/16	L	
F 121757/8,0M	8,0 5/16	M	
F 121757/8,0MH	8,0 5/16	MH	
F 121757/8,0H	8,0 5/16	H	

N121586 RIBATTITORE

Per "NECCHI"
For "NECCHI"

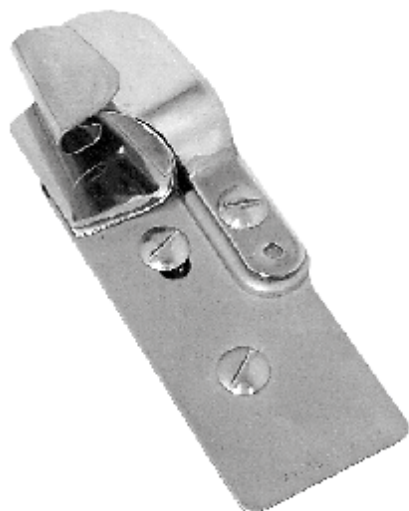

LAP SEAM FOLDER

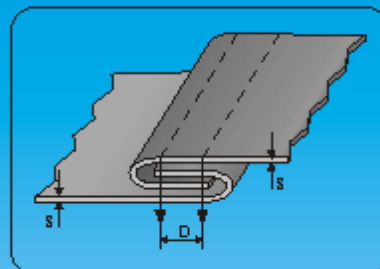

Codice	Dist. aghi (D) (gauge size) (mm) (inch)	Spessore (S) (thickness)
N 121586/4,8L	4,8 3/16	L
N 121586/4,8M	4,8 3/16	M
N 121586/4,8MH	4,8 3/16	MH
N 121586/4,8H	4,8 3/16	H
N 121586/6,4L	6,4 1/4	L
N 121586/6,4M	6,4 1/4	M
N 121586/6,4MH	6,4 1/4	MH
N 121586/6,4H	6,4 1/4	H
N 121586/6,4XH	6,4 1/4	XH
N 121586/8,0L	8,0 5/16	L
N 121586/8,0M	8,0 5/16	M
N 121586/8,0MH	8,0 5/16	MH
N 121586/8,0H	8,0 5/16	H
N 121586/8,0XH	8,0 5/16	XH



N121586/S - slitta tipo NECCHI (NECCHI type slide)
F121586/V - vite (screw)

R121586 RIBATTITORE

Per "RIMOLDI"
For "RIMOLDI"

PER CAMICERIA
FOR SHIRT FACTORY

PER JEANS
FOR JEANS

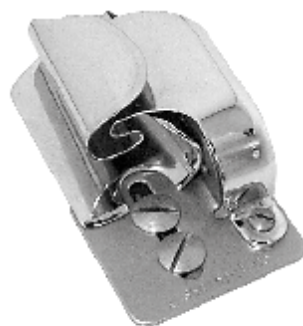

LAP SEAM FOLDER

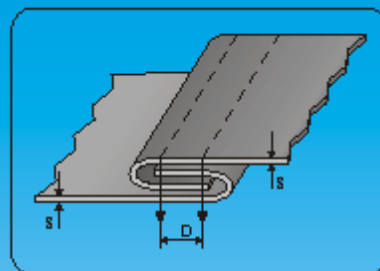

Codice	Dist. aghi (D) (gauge size) (mm) (inch)	Spessore (S) (thickness)
R 121586/4,8L	4,8 3/16	L
R 121586/4,8M	4,8 3/16	M
R 121586/4,8MH	4,8 3/16	MH
R 121586/4,8H	4,8 3/16	H
R 121586/6,4L	6,4 1/4	L
R 121586/6,4M	6,4 1/4	M
R 121586/6,4MH	6,4 1/4	MH
R 121586/6,4H	6,4 1/4	H
R 121586/6,4XH	6,4 1/4	XH

MISURE :
MEASURES :
4,8L - 4,8M - 4,8MH - 4,8H
6,4L - 6,4M

MISURE :
MEASURES :
6,4MH - 6,4H - 6,4XH

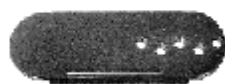

R121586/S - slitta tipo RIMOLDI (RIMOLDI type slide)
F121586/V - vite (screw)

F286 RIBATTITORE PER CARRE' CAMICIA

Per macchine piane 2 aghi
For 2 needle flat bed machines

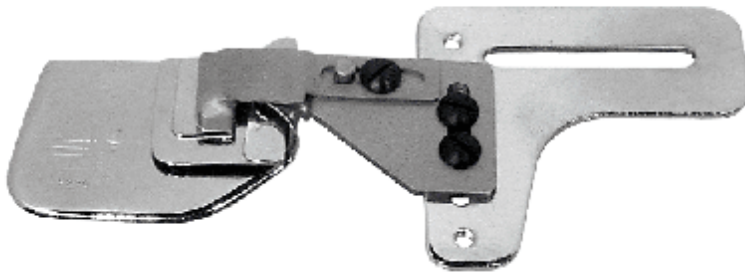

YOKE ATTACHMENT

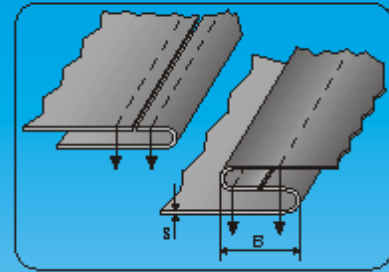

Codice	Lav. finito (B) (# finished size) (in) (out)	Spessore (S) (thickness)	
F286/10L	10 25/64	L	

F338 SET RIBATTITORE ALL'INGLESE PER CAMICERIA

Per macchine piane
For flat bed machines

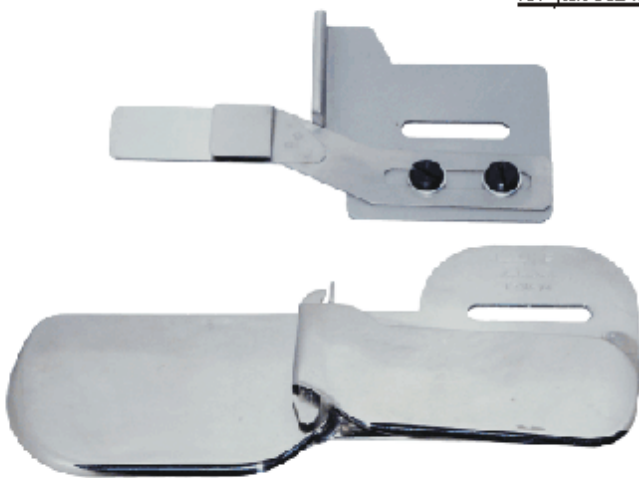

ENGLISH YOKE SET FOR SHIRT FACTORY

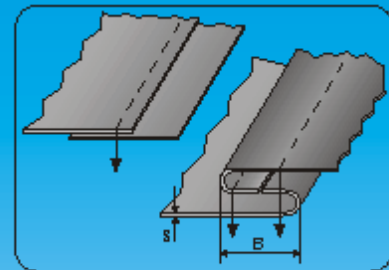

Codice	Dist. aghi (D) (gauge size) (in) (out)	Spessore (S) (thickness)	
F338/7L	7 9/32	L	
F338/7M	7 9/32	M	
F338/8L	8 5/16	L	
F338/8M	8 5/16	M	
F338/9L	9 11/32	L	
F338/9M	9 11/32	M	
F338/10L	10 3/8	L	
F338/10M	10 3/8	M	
F338/11L	11 7/16	L	
F338/11M	11 7/16	M	
F338/12L	12 1/2	L	
F338/12M	12 1/2	M	
F338/13L	13 33/64	L	
F338/13M	13 33/64	M	
F338/14L	14 9/16	L	
F338/14M	14 9/16	M	

F1050

GUIDA PER INSERIMENTO PROFILO

Per macchine piane
For flat bed machines

La loro finito (finished work)

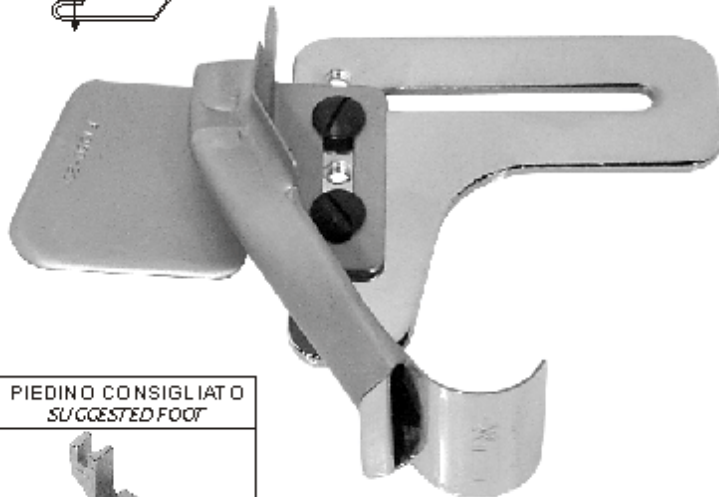
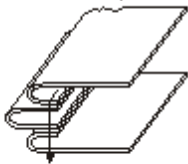

PIEDINO CONSIGLIATO
SUGGERED FOOT



G2360A - per tutte le misure
(for all sizes)

PIPING ATTACHMENT

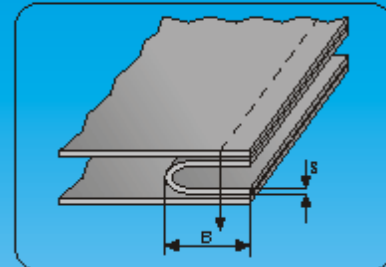

Codice	(A)	(B)	(S)	Codice	(A)	(B)	(S)
F1050/14M	14	7	M	F1050/40M	40	20	M
F1050/15M	15	7,5	M	F1050/40H	40	20	H
F1050/19M	19	9,5	M	F1050/45M	45	22,5	M
F1050/19H	19	9,5	H	F1050/45H	45	22,5	H
F1050/20M	20	10	M	F1050/50M	50	25	M
F1050/20H	20	10	H	F1050/50H	50	25	H
F1050/22M	22	11	M	F1050/55M	55	27,5	M
F1050/22H	22	11	H	F1050/55H	55	27,5	H
F1050/25M	25	12,5	M	F1050/60M	60	30	M
F1050/25H	25	12,5	H	F1050/60H	60	30	H
F1050/30M	30	15	M	F1050/70M	70	35	M
F1050/30H	30	15	H	F1050/70H	70	35	H
F1050/35M	35	17,5	M	F1050/90M	90	45	M
F1050/35H	35	17,5	H				

F1045

GUIDA PER PROFILO CON INSERIMENTO CORDONETTO

Per macchine piane
For flat bed machines

La loro finito (finished work)

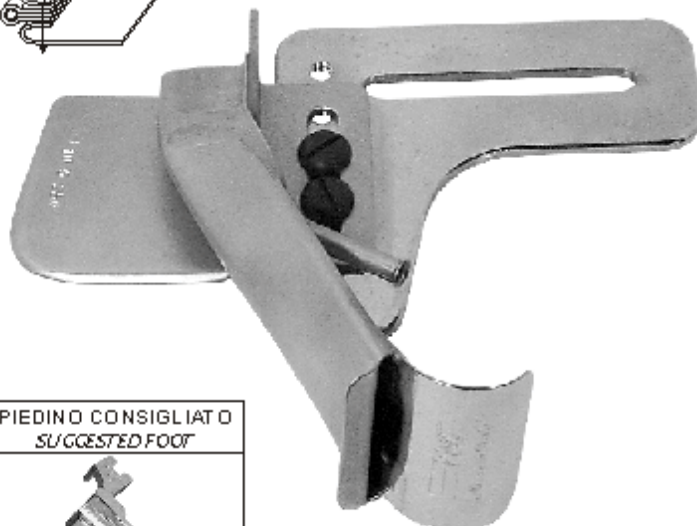
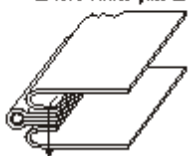

PIEDINO CONSIGLIATO
SUGGERED FOOT



G36069HL - per tutte le misure
(for all sizes)

CORD EDGE PIPING ATTACHMENT

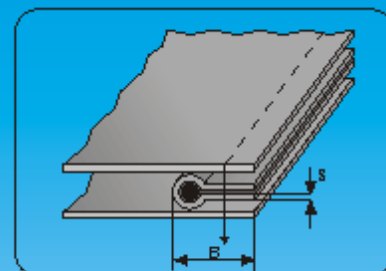

Codice	Entrata (A) (tape size) (in mm) (in ch)	Lav. finito (B) (finished size) (in mm) (in ch)	Spessore (S) (thickness)
F1045/19M	19 3/4	9,5 3/8	M
F1045/22M	22 7/8	11 7/16	M
F1045/25M	25 1	12,5 1/2	M
F1045/30M	30 1-3/16	15 19/32	M
F1045/35M	35 1-3/8	17,5 11/16	M

NOTA: USARE CORDINI ϕ 2 - 2,5 mm
NOTE: USE CORD ϕ 2 - 2,5 mm

F1040

GUIDA PER INSERIMENTO PROFILO

Lavoro finito (finished work)

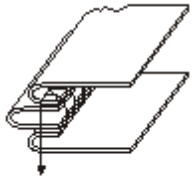

Per macchine taglia-cuci
For overlock machines



Consultare pag. 89 per i
parametri degli attacchi
da ritagliare.
Pls. see page 89 for
all brackets to be used

BIBING ATTACHMENT

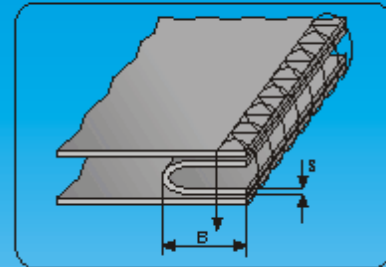

Codice	(A)	(B)	(S)	Codice	(A)	(B)	(S)
F1040/15M	15	7,5	M	F1040/40H	40	20	H
F1040/16M	16	8	M	F1040/45M	45	22,5	M
F1040/19M	19	9,5	M	F1040/45H	45	22,5	H
F1040/19H	19	9,5	H	F1040/50M	50	25	M
F1040/20M	20	10	M	F1040/50H	50	25	H
F1040/20H	20	10	H	F1040/55M	55	27,5	M
F1040/22M	22	11	M	F1040/55H	55	27,5	H
F1040/22H	22	11	H	F1040/60M	60	30	M
F1040/25M	25	12,5	M	F1040/60H	60	30	H
F1040/25H	25	12,5	H	F1040/70M	70	35	M
F1040/30M	30	15	M	F1040/70H	70	35	H
F1040/30H	30	15	H	F1040/80M	80	40	M
F1040/35M	35	17,5	M	F1040/90M	90	45	M
F1040/35H	35	17,5	H				
F1040/40M	40	20	M				

F1035

GUIDA PER PROFILO CON INSERIMENTO CORDONETTO

Lavoro finito (finished work)

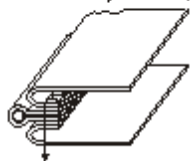

Per macchine taglia-cuci
For overlock machines



Consultare pag. 89 per i
parametri degli attacchi
da ritagliare.
Pls. see page 89 for
all brackets to be used

CORD EDGE PIPING ATTACHMENT

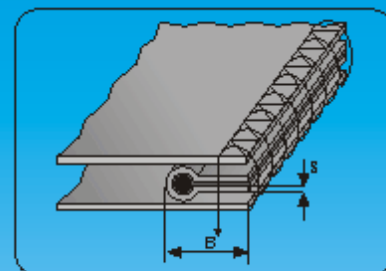

Codice	Entrata (A) (tape size) (in mm) (in inch)	Lav. finito (B) (finished size) (in mm) (in inch)	Spessore (S) (thickness)
F1035/19M	19 3/4	9,5 3/8	M
F1035/22M	22 7/8	11 7/16	M
F1035/25M	25 1	12,5 1/2	M
F1035/30M	30 1-3/16	15 19/32	M
F1035/35M	35 1-3/8	17,5 11/16	M

NOTA: USARE CORDINI DI Ø 2 - 2,5 mm

NOTE: USE CORD Ø 2 - 2,5 mm

F365 GUIDA PER INSERIMENTO BANDA PREFABBRICATA

READY-MADE EDGING ATTACHMENT

La loro finito (finished work)

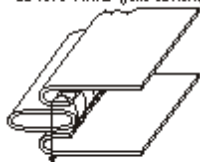

Per macchine taglia-cuci
For overlock machines



Consultare pag. 89 per la
parametri degli attacchi
da utilizzare.

*Pls. see page 89 for
all brackets to be used*

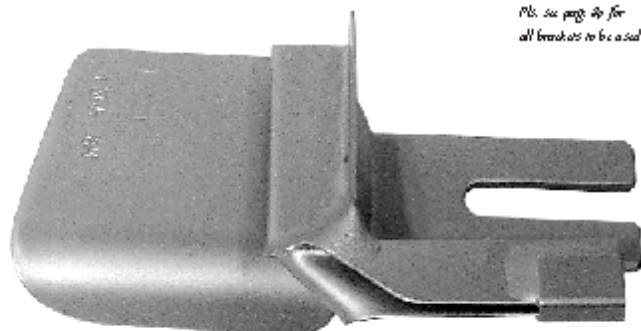
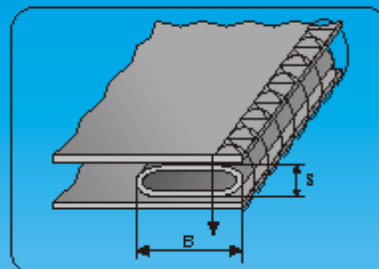

Codice	Mis. banda (B) (edging size) (mm) (inch)	Spessore (S) (thickness) (mm)
F365/7M	7 9/32	M
F365/8M	8 5/16	M
F365/9M	9 23/64	M
F365/10M	10 25/64	M
F365/10H	10 25/64	H
F365/12H	12 15/32	H

F1140 GUIDA REGOLABILE PER INSERIMENTO DOPPIO PROFILO

DOUBLE ADJUSTABLE PIPING ATTACHMENT

La loro finito (finished work)

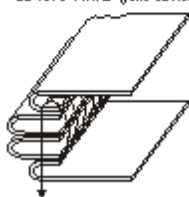

Per macchine taglia-cuci
For overlock machines

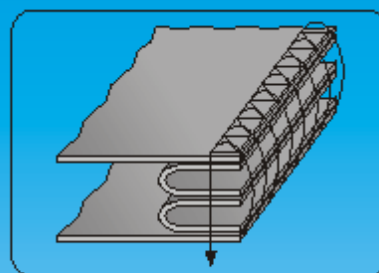
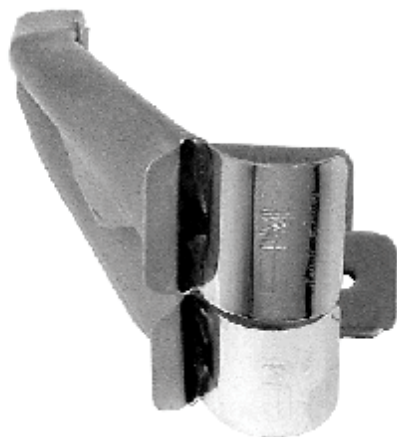

Consultare pag. 89 per la
parametri degli attacchi
da utilizzare.

*Pls. see page 89 for
all brackets to be used*

Codice	Entrata (A) (tape size) (mm)	Lav. finito (B) (finished size) (mm)	Spessore (S) (thickness) (mm)
--------	------------------------------------	--	-------------------------------------

L'APPARECCHIO VIENE FORNITO SU RICHIESTA
Con l'ordinazione è necessario che ci siano inviati i
campioni del materiale che deve essere utilizzato.

MANUFACTURED ON REQUEST

*With the order we need to receive both samples of
material to be used.*

F1184 GUIDA PASSAELASTICO CON INSERIMENTO ELASTICO CON CORDINO

*Per "RIMOLDI", ecc.
For "RIMOLDI", etc.*

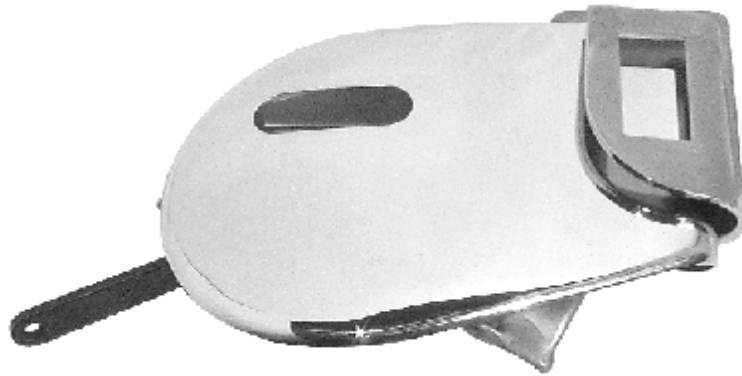

DOWNTURN HEMMER WITH ELASTIC WITH CORD INSERTION

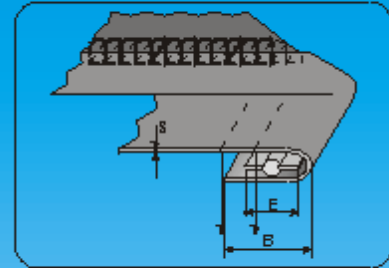

Codice	Lav. finito (B)		Elastico (E)		Spessore (S)
	(in tied size)	(in)	(in tied size)	(in)	

GLI APPARECCHI VENGONO FORNITI SU RICHIESTA

Con l'ordinazione è necessario che ci siano inviati sia il campione della fettuccia, sia il campione dell'elastico che devono essere utilizzati.

MANUFACTURED ON REQUEST

With the order we need to receive both sample of tape to be used and sample of elastic.

F1187 GUIDA PASSAELASTICO CON ORLO SEMPLICE

Per macchine a 4 aghi
For 4 needle machines



SINGLE DOWNTURN ELASTIC HEMMER

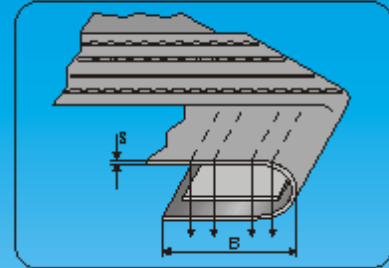

Codice	Lav. finito (B)		Elastico (E)		Spessore (S)
	(in) (in)	(in) (in)	(in) (in)	(in) (in)	
F1187/33M	33	1-19/64	25	1	M
F1187/38M	38	1-1/2	30	1-3/16	M
F1187/38H	38	1-1/2	30	1-3/16	H
F1187/41M	41	1-39/64	33	1-19/64	M
F1187/41H	41	1-39/64	33	1-19/64	H
F1187/44M	44	1-3/4	36	1-7/16	M
F1187/44H	44	1-3/4	36	1-7/16	H
F1187/50M	50	2	42	1-11/16	M

F1292 GUIDA PASSAELASTICO CON ORLO DOPPIO

Per macchine a 4 aghi
For 4 needle machines



DOUBLE DOWNTURN ELASTIC HEMMER

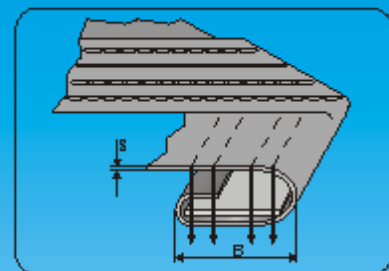

Codice	Lav. finito (B)		Elastico (E)		Spessore (S)
	(in) (in)	(in) (in)	(in) (in)	(in) (in)	
F 1292/25M	25	1	23	29/32	M
F 1292/25H	25	1	23	29/32	H
F 1292/30L	30	1-3/16	28	1-1/8	L
F 1292/30M	30	1-3/16	28	1-1/8	M
F 1292/30H	30	1-3/16	28	1-1/8	H
F 1292/36L	36	1-7/16	34	1-11/32	L
F 1292/36M	36	1-7/16	34	1-11/32	M
F 1292/36H	36	1-7/16	34	1-11/32	H
F 1292/42M	42	1-21/32	40	1-9/16	M

F414 - 415 - 416 - 417

Per macchine a 4 aghi
For 4 needle machines



Codice	Lav. finito (B) (finished size) (mm) (inch)	Elastico (E) (elastic size) (mm) (inch)	Spessore (S) (thickness)
--------	---	---	-----------------------------

GLI APPARECCHI VENGONO FORNITI SU RICHIESTA

Con l'ordinazione è necessario che ci siano inviati sia il campione della fettuccia, sia il campione dell'elastico che devono essere utilizzati.

MANUFACTURED ON REQUEST

With the order we need to receive both sample of tape to be used and sample of elastic.

F414

GUIDA PASSAELASTICO CON INSERIMENTO DI ELASTICO CON CORDINO
DOUBLE DOWNTURN HEMMER
WITH ELASTIC WITH CORD INSERTION

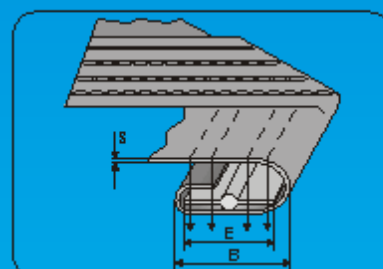

F415

GUIDA PASSAELASTICO CON INSERIMENTO DI 2 ELASTICI E CORDINO
DOUBLE DOWNTURN HEMMER
WITH TWO ELASTICS AND CORD INSERTION

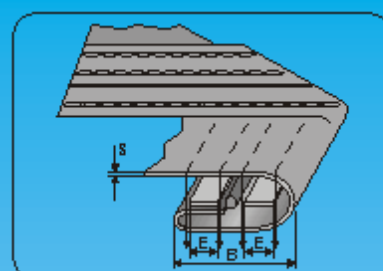

F416

GUIDA PASSAELASTICO CON INSERIMENTO DI 2 ELASTICI
DOUBLE DOWNTURN HEMMER
WITH TWO ELASTICS INSERTION

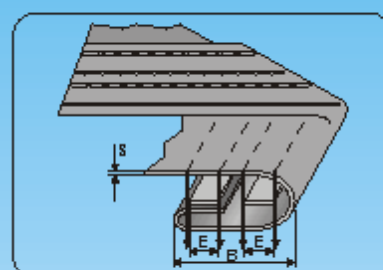

F417

GUIDA PASSAELASTICO CON INSERIMENTO DI 3 ELASTICI
DOUBLE DOWNTURN HEMMER
WITH THREE ELASTICS INSERTION

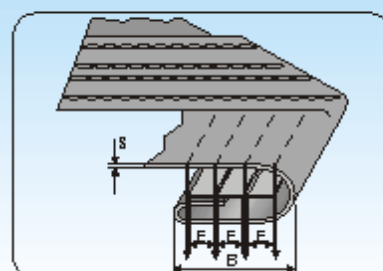

F425 GUIDA PER PASSANTI DOPPIO RISVOLTO BORDI SFALSATI

Per macchine piane a 1 ago
For 1 needle flat bed machines

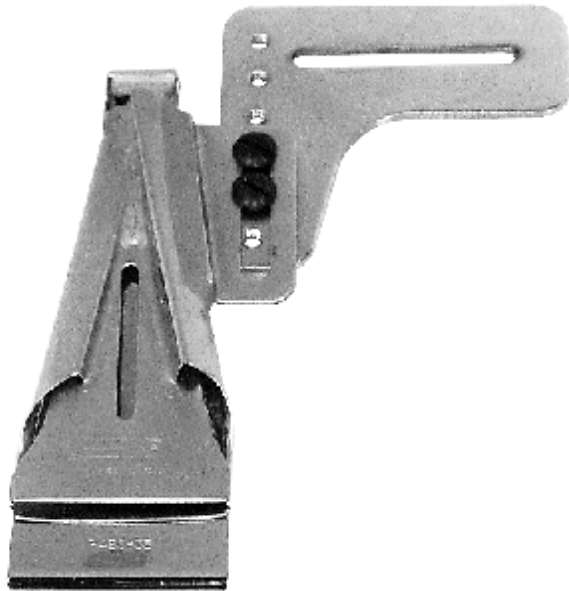

DOUBLE BELT LOOP FOLDER

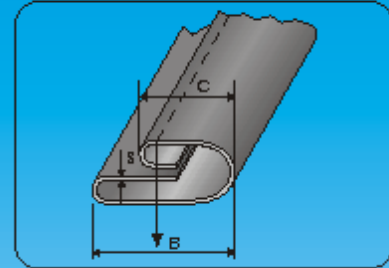

Codice	Entrata (A) (tape size) (mm) (inch)	Piega inf. (B) (lower fold) (mm) (inch)	Piega sup. (C) (upper fold) (mm) (inch)
F425/25	25 1	10 25/64	6 1/4
F425/30	30 1-3/16	12 31/64	7 9/32
F425/35	35 1-3/8	14 9/16	8 5/16
F425/40	40 1-9/16	16 5/8	9 23/64
F425/50	50 2	20 25/32	11 7/16

QUESTO APPARECCHIO CONSENTE LA FABBRICAZIONE DI PASSANTI E CINTURE SU MACCHINE PIANE AD UN AGO, MEDIANTE UNA SOLA CU CITURA CENTRALE.

THIS ATTACHMENT ALLOWS THE MANUFACTURE OF LOOPS AND BELTS WITH ONE NEEDLE FLAT BED MACHINES, BY ONE CENTRAL STITCH ONLY.

F428 GUIDA PER SPALLINE DOPPIO RISVOLTO BORDI SFALSATI CON INSERIMENTO DI ELASTICO

Per macchine piane a 1 ago
For 1 needle flat bed machines

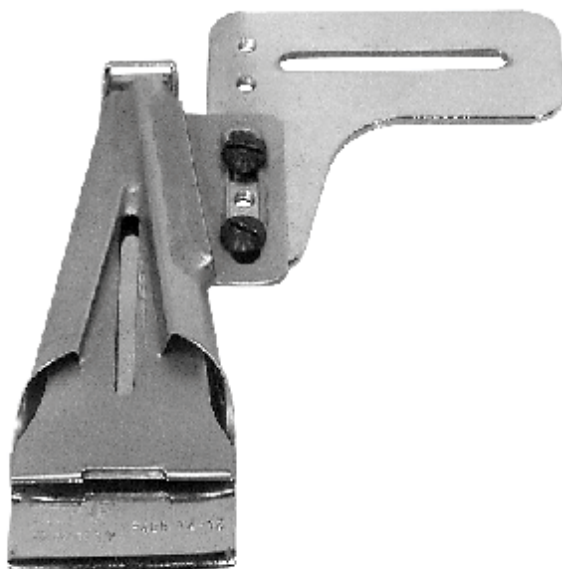

DOUBLE BELT LOOP FOLDER
WITH ELASTIC INSERTION

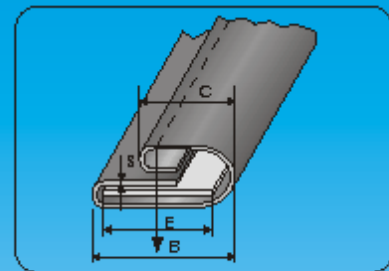

Codice	Entrata (A) (tape size) (mm) (inch)	Piega inf. (B) (lower fold) (mm) (inch)	Piega sup. (C) (upper fold) (mm) (inch)	Elastico (E) (elastic) (mm) (inch)
F428/25	25 1	10 25/64	6 1/4	8 5/16
F428/30	30 1-3/16	12 31/64	7 9/32	10 25/64
F428/35	35 1-3/8	14 9/16	8 5/16	12 31/64
F428/40	40 1-9/16	16 5/8	9 23/64	15 19/32
F428/50	50 2	20 25/32	11 7/16	18 23/32

QUESTO APPARECCHIO CONSENTE LA FABBRICAZIONE DI SPALLINE CON ELASTICO, SU MACCHINE PIANE AD UN AGO, MEDIANTE UNA SOLA CU CITURA CENTRALE.

THIS ATTACHMENT ALLOWS THE MANUFACTURE OF ELASTIC SHOULDER STRIPS WITH ONE NEEDLE FLAT BED MACHINES, BY ONE CENTRAL STITCH ONLY.

F445 GUIDA PER BRETELLE

CF: GO 300

Per macchine piane a 2 aghi
For 2 needles flat bed machines



CENTER-STITCH BRACES FOLDER

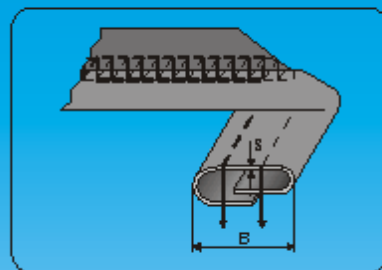

Codice	Entrata (A) (tape size)		Lav. finito (B) (finished size)		Spessore (S) (thickness)
	(mm)	(inch)	(mm)	(inch)	
F445/20	20	25/32	8	5/16	M
F445/23	23	29/32	10	25/64	M
F445/30	30	1-3/16	13	33/64	M
F445/34	34	1-11/32	15	19/32	M
F445/42	42	1-21/32	18	23/32	M
F445/45	45	1-3/4	20	25/32	MH
F445/50	50	2	23	29/32	MH
F445/60	60	2-3/8	27	1-1/16	MH
F445/70	70	2-3/4	32	1-1/4	MH
F445/80	80	3-3/16	37	1-29/64	MH

F465 GUIDA REGOLABILE PER L'APPLICAZIONE DI STRISCE CIMOSATE

Per macchine piane 2 aghi
For 2 needles flat bed machines

ADJUSTABLE ATTACHMENT TO APPLY SELVEDGED STRIPS

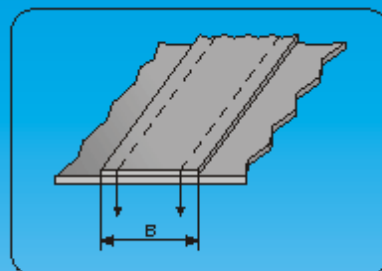

Consultare pag. 89 per la
pavimentazione degli attacchi
da utilizzare.
Please see pag. 89 for
all brackets to be used

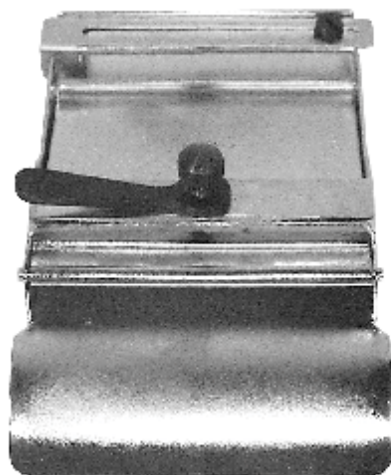

Codice	Lav. finito (B) (finished size) (mm)	Spessore (S) (thickness)
F465/40	da 0 a 40	M H
F465/60	da 0 a 60	M H
F465/100	da 0 a 100	M H



F465/95 - levetta (lever)
F465/96 - vite (screw)

F1195

GUIDA PER APPLICAZIONE BANDE

Per macchine piane 2 aghi
For 2 needle flat bed machines

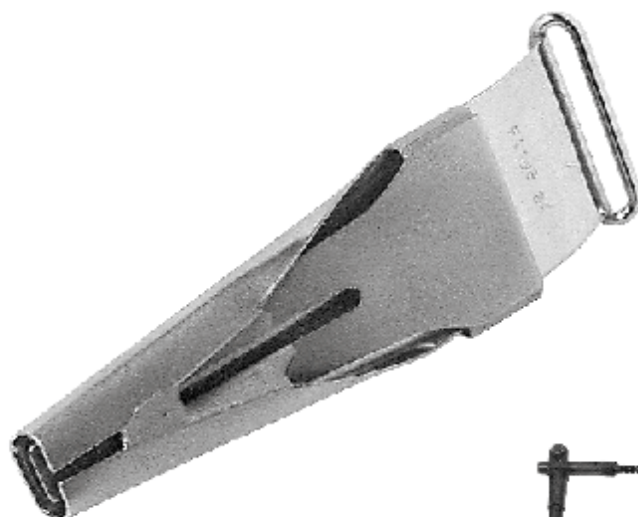

Consultare pag. 89 per le
parametri degli attacchi
da utilizzare.
Pls. see page 89 for
attachments to be used

TAPE FOLDER

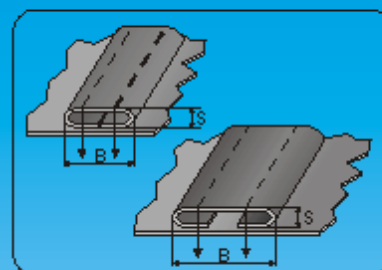

Codice	(A)	(B)	(S)	Codice	(A)	(B)	(S)
F 1195/12	12	6	M	F 1195/47	47	29	M
F 1195/14	14	7	M	F 1195/50	50	32	M
F 1195/16	16	8	M	F 1195/54	54	36	M
F 1195/18	18	9	M	F 1195/60	60	42	M
F 1195/20	20	10	M	F 1195/73	73	55	M
F 1195/22	22	11	M	F 1195/100	100	75	M
F 1195/24	24	12	M				
F 1195/26	26	13	M				
F 1195/28	28	14	M	F 1195/18H	18	9	H
F 1195/30	30	15	M	F 1195/20H	20	10	H
F 1195/32	32	16	M	F 1195/22H	22	11	H
F 1195/35	35	17,5	M	F 1195/26H	26	13	H
F 1195/38	38	19	M	F 1195/28H	28	14	H
F 1195/40	40	22	M	F 1195/30H	30	15	H
F 1195/44	44	26	M	F 1195/38H	38	19	H

F1195B

GUIDA PER APPLICAZIONE BANDE CON GUIDA

Per macchine piane 2 aghi
For 2 needle flat bed machines

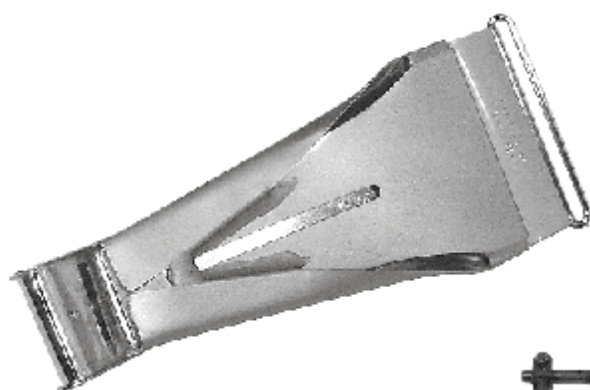

Consultare pag. 89 per le
parametri degli attacchi
da utilizzare.
Pls. see page 89 for
attachments to be used

TAPE FOLDER LARGE

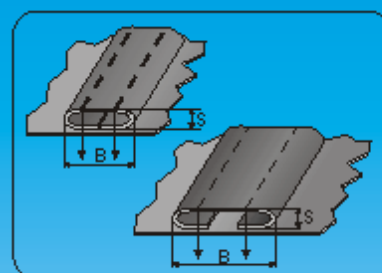

Codice	Entrata (A) (tape size) (mm) (inch)	Lav. finito (B) (finished size) (mm) (inch)	Spessore (S) (thickness)
F 1195B/40	40 1-9/16	22 7/8	M
F 1195B/44	44 1-3/4	26 1-1/32	M
F 1195B/47	47 1-13/16	29 1-1/8	M
F 1195B/50	50 2	32 1-1/4	M
F 1195B/54	54 2-3/16	36 1-27/64	M
F 1195B/60	60 2-3/8	42 1-21/32	M
F 1195B/73	73 2-29/32	55 2-3/16	M
F 1195B/100	100 4	75 2-31/32	M

F1200 GUIDA PER BANDE DOPPIA CON INSERIMENTO DI ELASTICO

Per macchine piane a 2 aghi
For 2 needle flat bed machines



Costituito pag. 89 per la
parte amica degli attacchi
da filezzare.
Pls. see page 89 for
all the details to be used

DOUBLE TAPE FOLDER WITH ELASTIC INSERTION

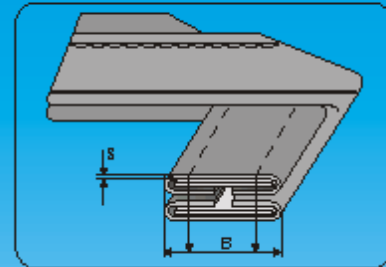

Codice	Lav. finito (B) (in) (fed size) (mm) (inch)	Elastico (E) (in) (fed size) (mm) (inch)	Spessore (S) (thickness)
--------	---	--	-----------------------------

LA GUIDA VIENE FORNITA SU RICHIESTA

Con l'ordinazione è necessario che ci siano inviati sia
il campione delle fettucce, sia il campione dell'elastico
che devono essere utilizzati.

MANUFACTURED ON REQUEST

With the order we need to receive both sample of tape
to be used and sample of elastic.

F1248 GUIDA PER CINTURE SAGOMATE

Per macchine piane 2 aghi
For 2 needle flat bed machines

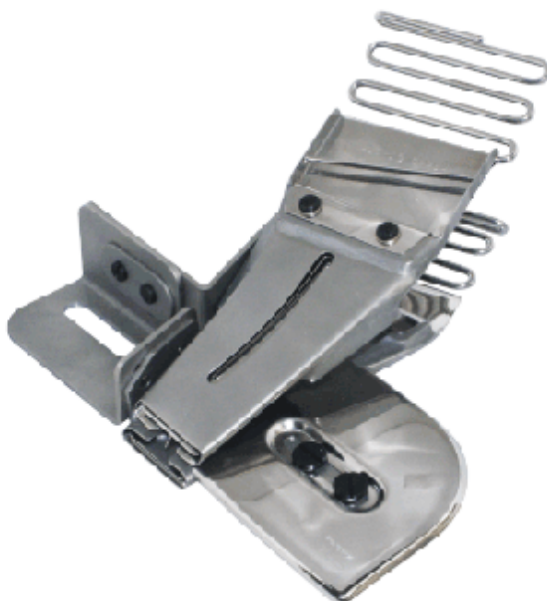

GUIDE FOR SHAPED BELTS

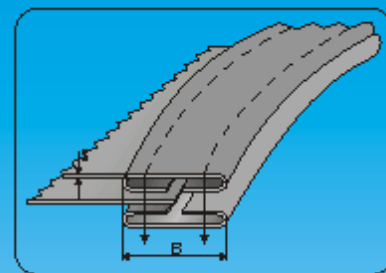

Codice	Entrata (A) (tape size) (mm) (inch)	Lav. finito (B) (in) (fed size) (mm) (inch)	Spessore (S) (thickness)
F1248/60	60 2-3/8	35 1-3/8	M
F1248/63	63 2-1/2	37 1-1/2	M
F1248/70	70 2-3/4	44 1-3/4	M
F1248/76	76 3-1/2	50 2	M
F1248/60MH	60 2-3/8	35 1-3/8	MH
F1248/63MH	63 2-1/2	37 1-1/2	MH
F1248/70MH	70 2-3/4	44 1-3/4	MH
F1248/76MH	76 3-1/2	50 2	MH

NOTA:
a richiesta fornibili
con passaggio "H"

NOTE
available on request with "H" passage

F485 GUIDA PER L' APPLICAZIONE DI UNA STRISCIA RIMBOCCATA

Per macchine piano 1 ago
For 1 needle flat bed machines



PIEDINO CONSIGLIATO
SUGGESTED FOOT

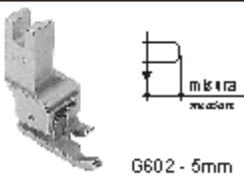

Consultare pag. 89 per le
 particolarità degli attacchi
 da ritagliare.
 Pls. see page 89 for
 all brackets to be used

LAY-ON FOLDER

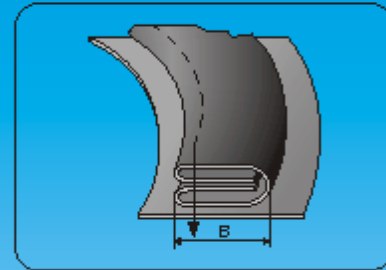

Codice	Entrata (A) (tape size) (mm) (inch)	Lav. finito (B) (finished size) (mm) (inch)	Spessore (S) (thickness)
F485/20	20 25/32	6 1/4	M

F1055 GUIDA A PIEGA SEMPLICE

Per macchine taglia-cuci
For overlock machines

La loro finità (finished work)

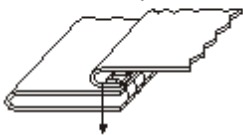

Consultare pag. 89 per le
 particolarità degli attacchi
 da ritagliare.
 Pls. see page 89 for
 all brackets to be used

OVERLOCK FOLDER

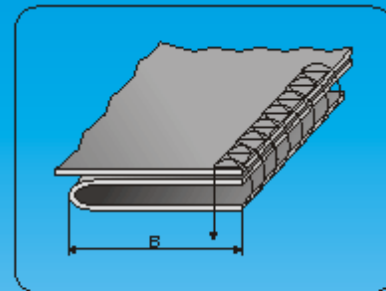

Codice	(A)	(B)	(S)	Codice	(A)	(B)	(S)
F1055/30M	30	15	M	F1055/120M	120	60	M
F1055/35M	35	17,5	M	F1055/120H	120	60	H
F1055/40M	40	20	M	F1055/140L	140	70	L
F1055/45M	45	22,5	M	F1055/140M	140	70	M
F1055/50M	50	25	M	F1055/140H	140	70	H
F1055/56M	56	28	M	F1055/200M	200	100	M
F1055/56H	56	28	H				
F1055/64M	64	32	M				
F1055/64H	64	32	H				
F1055/76M	76	38	M				
F1055/80M	80	40	M				
F1055/80H	80	40	H				
F1055/90M	90	45	M				
F1055/90H	90	45	H				
F1055/100M	100	50	M				

F53 GUIDA PER SPAGHETTI

Per macchine piane
For flat bed machines

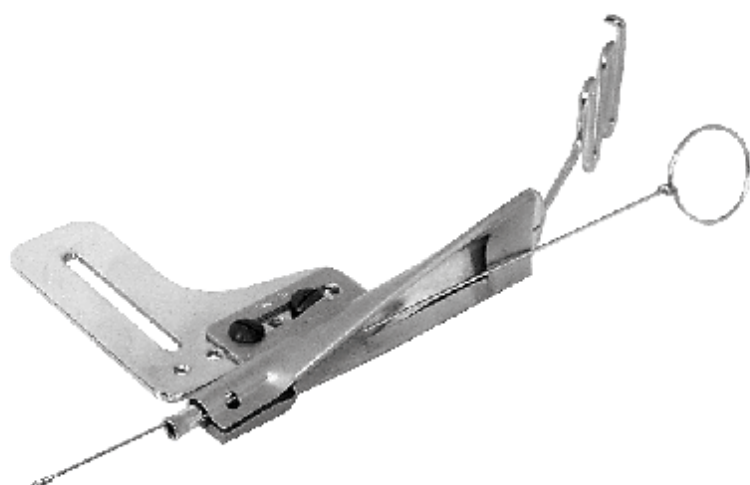

SPAGHETTI ATTACHMENT

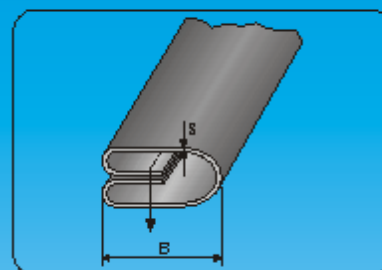

Codice	Entrata (A) (tape size) (mm) (inch)	Lav. finito (B) (finished size) (mm) (inch)	Spessore (S) (thickness)
F53/14	14 9/16	3,5 9/64	M
F53/16	16 5/8	4 5/32	M
F53/19	19 3/4	5 13/64	M
F53/22	22 7/8	5,5 7/32	M
F53/25	25 1	6 15/64	M
F53/28	28 1-1/8	8 5/16	M
F53/30	30 1-3/16	8,7 11/32	M
F53/32	32 1-1/4	9,5 3/8	M
F53/35	35 1-3/8	10 25/64	M
F53/38	38 1-1/2	11 7/16	M

F54 GUIDA PER SPAGHETTI

Per macchine taglia-cuci
For overlock machines

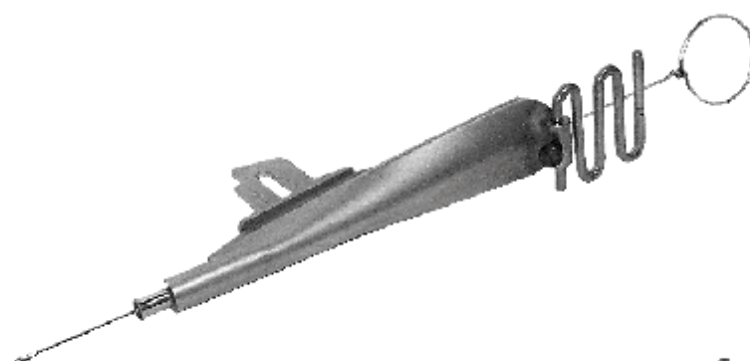

Consultare pag. 89 per la
posizione dei tagliatori
da utilizzare.
Pls. see page 89 for
all brackets to be used

SPAGHETTI ATTACHMENT

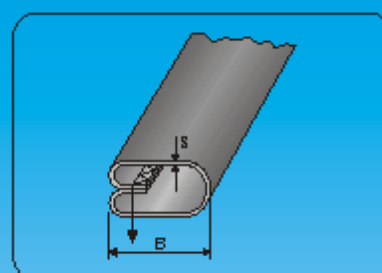

Codice	Entrata (A) (tape size) (mm) (inch)	Lav. finito (B) (finished size) (mm) (inch)	Spessore (S) (thickness)
F54/14	14 9/16	3,5 9/64	M
F54/16	16 5/8	4 5/32	M
F54/19	19 3/4	5 13/64	M
F54/22	22 7/8	5,5 7/32	M
F54/25	25 1	6 15/64	M
F54/28	28 1-1/8	8 5/16	M
F54/30	30 1-3/16	8,7 11/32	M
F54/32	32 1-1/4	9,5 3/8	M
F54/35	35 1-3/8	10 25/64	M
F54/38	38 1-1/2	11 7/16	M



F153 GUIDA PER SPAGHETTI CON INSERIMENTO DI ELASTICO

*Per macchine taglia-cuci
For overlock machines*

SPAGHETTI ATTACHMENT WITH ELASTIC INSERTION

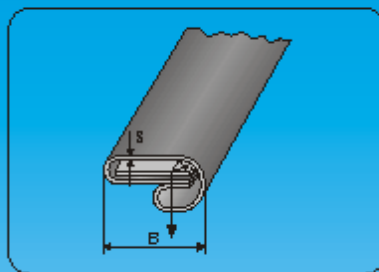

Codice	Lav. finito (B) (ft. bed size) (mm) (inch)	Elastico (E) (e. be. thk size) (mm) (inch)	Spessore (S) (thickness)
--------	--	--	-----------------------------

LA GUIDA VIENE FORNITA SU RICHIESTA

Con l'ordinazione è necessario che ci siano inviati sia il campione della fettuccia, sia il campione dell'elastico che devono essere utilizzati.

MANUFACTURED ON REQUEST

With the order we need to receive both sample of tape to be used and sample of elastic.

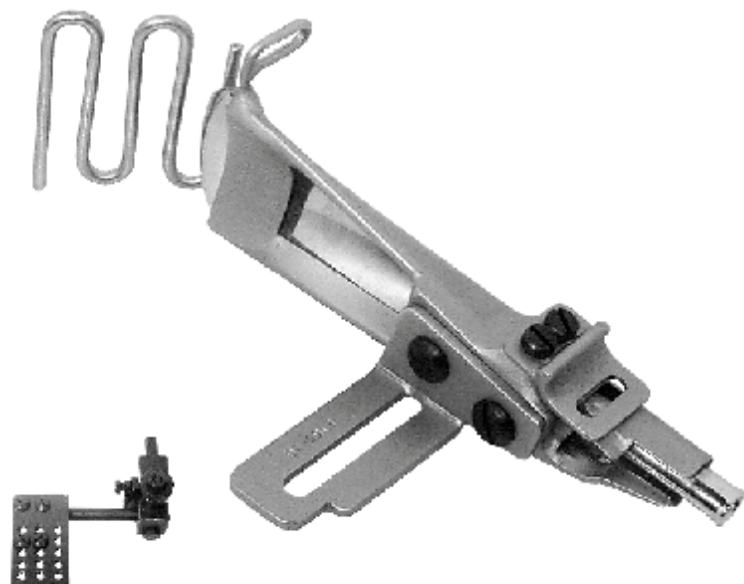

Consultare pag. 89 per la procedura degli attacchi da utilizzare.
Pls. see pag. 89 for all brackets to be used

F52 GUIDA PER FETTUCCHE - REGOLABILE

*Per macchine piane
For flat bed machines*

ADJUSTABLE ATTACHMENT

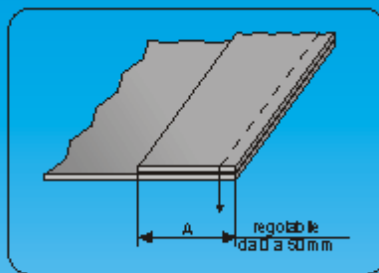

Codice	Entrata (A) (tape size) (mm)		
F52/50	da 0 a 50		

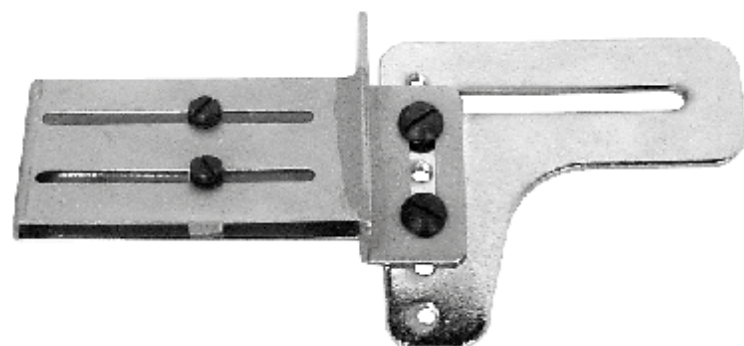

F271 GUIDA DI BATTUTA

GAUGE GUIDE

Per macchine piane
For flat bed machines



F204075 GUIDA DI BATTUTA

GAUGE GUIDE

Per macchine piane
For flat bed machines

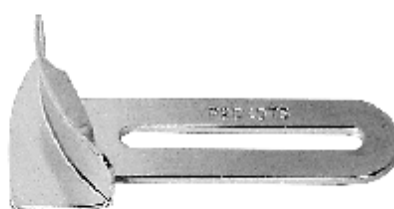

F310006 GUIDA DI BATTUTA

GAUGE GUIDE

Per macchine piane
For flat bed machines



F310012 GUIDA DI BATTUTA

GAUGE GUIDE

Per macchine piane
For flat bed machines



F310013 GUIDA DI BATTUTA

GAUGE GUIDE

Per macchine piane
For flat bed machines



F310015 GUIDA DI BATTUTA

GAUGE GUIDE

Per macchine piane
For flat bed machines



F310040 GUIDA DI BATTUTA

GAUGE GUIDE

Per macchine piane
For flat bed machines

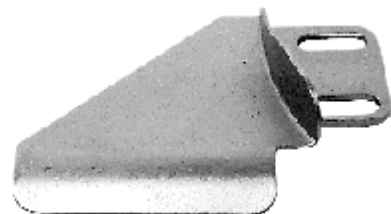

F1090 ARRICCIATORE

SHIRTING ATTACHMENT

Per macchine piane
For flat bed machines

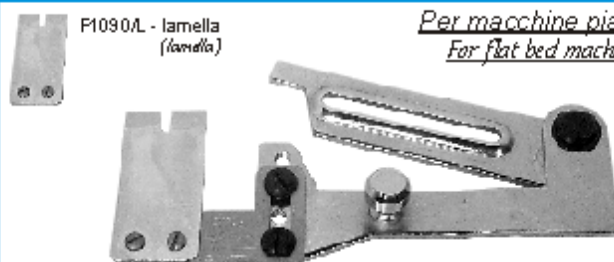

F2002 GUIDA PASSAELASTICO

ELASTIC INSERTION GUIDE

Per macchine taglia-cuci
For overlock machines



F1106 STAFFA UNIVERSALE REGOLABILE

UNIVERSAL ADJUSTABLE BRACKET

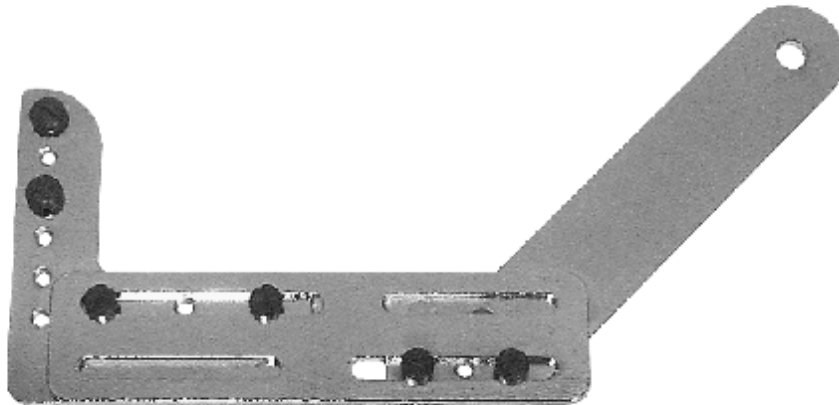

Per macchine piane
For flat bed machines

PARTICOLARIA CORREDO

EQUIPPED PARTS



F1106/M - Molla
(Spring)



F1106/V - Vite
(Screw)

NUOVA STAFFA UNIVERSALE PER TUTTE LE MACCHINE PIANE.
ADATTA PER TUTTI I TIPI DI APPARECCHI, E PARTICOLARMENTE
INDICATA PER QUELLI DI GRANDI DIMENSIONI O PER
PARTICOLARI LAVORAZIONI CHE NECESSITANO DI UNA VASTA
GAMMA DI REGOLAZIONI.

NEW UNIVERSAL BRACKET FOR ALL FLAT BED MACHINES.
SUITABLE FOR ALL TYPES OF ATTACHMENTS AND ESPECIALLY
SUGGESTED FOR THE LARGE DIMENSIONS ONES OR SPECIAL WORKS
WHICH NEED OF A WIDE SCALE OF ADJUSTMENTS.

Staffe (Brackets)

STAFFA UNIVERSALE

UNIVERSAL BRACKET

Per macchine piane
For flat bed machines

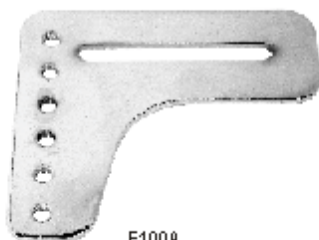

F100A

STAFFE APRIBILI

SWING BRACKETS

Per macchine piane
For flat bed machines

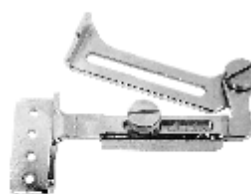

F72B/S

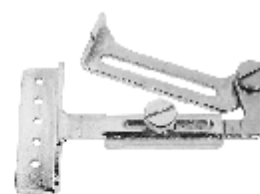

F72PVS



F105 GA/S

STAFFA PER F69

BRACKET FOR F69

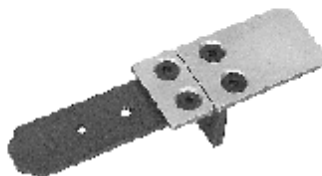

F69A

STAFFA PER F601 - F604

BRACKET FOR F601 - F604



F604A

STAFFA PER F704, F705

BRACKET FOR F704, F705



F704A

ATTACCO UNIVERSALE

PER F31000 - F31002

UNIVERSAL BRACKET FOR F31000 - F31002



F31001S

ATTACCO TIPO "RIMOLDI"

PER F31000 - F31002

"RIMOLDI" TYPE BRACKET FOR F31000 - F31002



F31001R

STAFFA PER F34000 - F34002

BRACKET FOR F34000 - F34002



F34000A

F1110 ATTACCO UNIVERSALE UNIVERSAL BRACKET

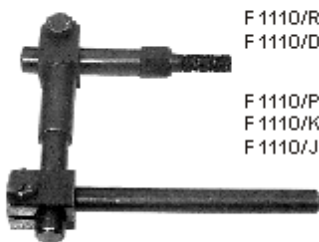

F 1110/R - per : RIMOLDI (M6)
 F 1110/D - per : DÜRKOPP (M4)
 PEGASUS (M4)
 YAMATO (M4)
 F 1110/P - per : PFAFF (M5)
 F 1110/K - per : KANSAI (M 4,35 x 0,63)
 F 1110/J - per : JUKI (F 0,90T)

F1111 ATTACCO UNIVERSALE - DOPPIO UNIVERSAL BRACKET - DOUBLE

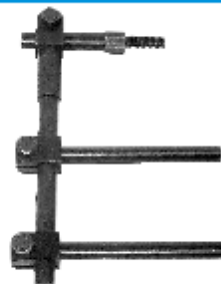

F 1111/R - per : RIMOLDI (M6)
 F 1111/D - per : DÜRKOPP (M4)
 PEGASUS (M4)
 YAMATO (M4)
 F 1111/P - per : PFAFF (M5)
 F 1111/K - per : KANSAI (M 4,35 x 0,63)
 F 1111/J - per : JUKI (F 0,90T)

F1105 ATTACCO PER TAGLIA-CUCI "RIMOLDI" BRACKET FOR "RIMOLDI" OVERLOCK

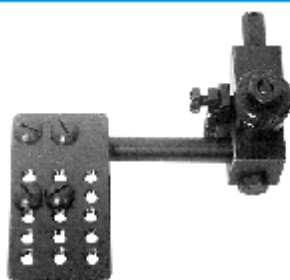

F1103 ATTACCO PER TAGLIA-CUCI "UNION SPECIAL" BRACKET FOR "UNION SPECIAL" OVERLOCK



F1102 ATTACCO PER TAGLIA-CUCI "BROTHER" BRACKET FOR "BROTHER" OVERLOCK

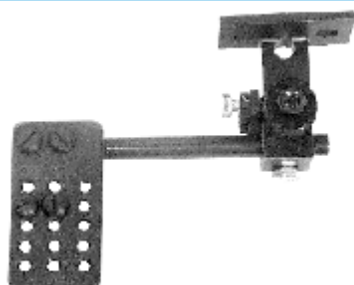

F1104 ATTACCO PER TAGLIA-CUCI "JUKI" BRACKET FOR "JUKI" OVERLOCK

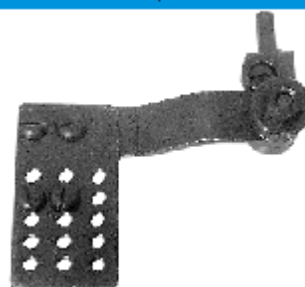

F1100 ATTACCO PER TAGLIA-CUCI "YAMATO" (Reg.) BRACKET FOR "YAMATO" OVERLOCK (Adjustable)



F1112 ATTACCO PER TAGLIA-CUCI "W.&G." (V. tipo) BRACKET FOR "W. & G." OVERLOCK (Old type)

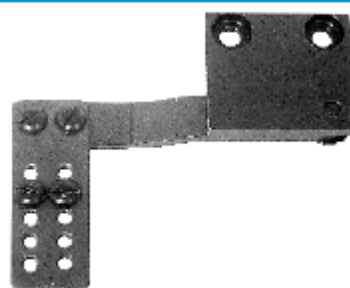

F1114 ATTACCO PER TAGLIA-CUCI "W.&G." (N. tipo) BRACKET FOR "W. & G." OVERLOCK (New type)



F516 FRENAGGIO SUPERIORE

UPPER TAPE RACK TENSION

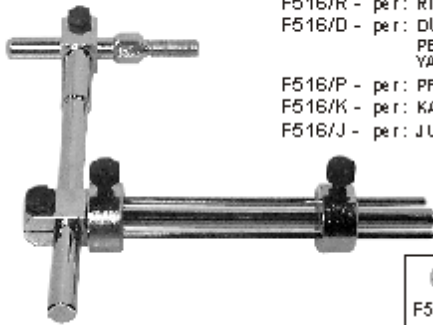

F516/R - per: RIMOLDI (M6)
 F516/D - per: DÜRKOPP (M6)
 PEGAS US, (M6)
 YAMATO (M6)
 F516/P - per: PFAFF (M6)
 F516/K - per: KANSAI (M 4,35 x 0,63)
 F516/J - per: JUKI (F 0,907)

F516/10 - splitto per JUKI
 - (pin for JUKI)

F517 FRENAGGIO LATERALE

SIDE TAPE RACK TENSION

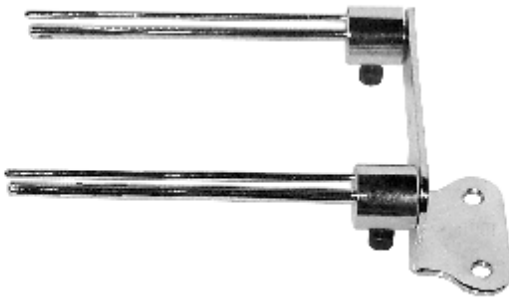

6190 FRENAGGIO REGOLABILE PER FETTUCCE

ADJUSTABLE TAPE RACK TENSION



F519 FRENAGGIO LATEROLE - ORIENTABILE

SIDE TAPE RACK TENSION - ADJUSTABLE

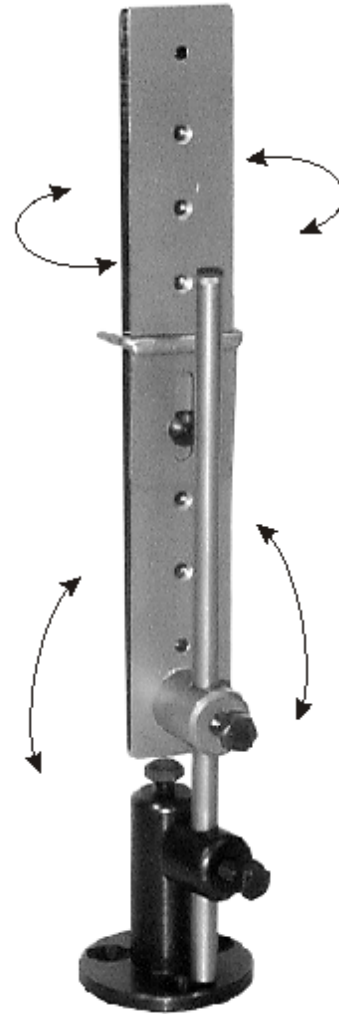

F1240 - 1241 FRENAGGI PER ELASTICO

TAPE RACK TENSIONS FOR ELASTIC

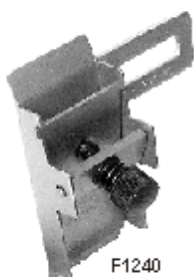

F1240/M - molla (spring)
 F1240/V - vite (screws)
 F1240/L... - time la (bracket)
 - specificare in misura -
 - specify measure -

Codice	Elastico (E) (mm) (inch)	Codice	Bastico (E) (mm) (inch)
F 1240/8	8 5/16	F1241/8	8 5/16
F 1240/10	10 25/64	F1241/10	10 25/64
F 1240/12	12 15/32	F1241/12	12 15/32
F 1240/15	15 19/32	F1241/15	15 19/32
F 1240/20	20 25/32	F1241/20	20 25/32
F 1240/25	25 1	F1241/25	25 1
F 1240/30	30 1-3/16	F1241/30	30 1-3/16
F 1240/35	35 1-3/8	F1241/35	35 1-3/8
F 1240/40	40 1-9/16	F1241/40	40 1-9/16

INDICE PER CODICI

<i>IPO</i>	<i>DESCRIZIONE</i>	<i>PAG.</i>	<i>TIPO</i>	<i>DESCRIZIONE</i>	<i>PAG.</i>	<i>TIPO</i>	<i>DESCRIZIONE</i>	<i>PAG.</i>
F19	ORLATORE	3	F206	ORLATORE	15	F1105	ATTACCO	89
F21	ORLATORE	3	F206GA	ORLATORE	15	F1106	STAFFA UNIVERSALE	88
F40	COLLARETTO	50	F265	COLLARETTO	53	F1106/M	MOLLA	88
F40B	COLLARETTO	50	F270	ORLATORE	6	F1106/V	VITE	88
F40H	COLLARETTO	50	F271	GUIDA BATTUTA	87	F1110/R	ATTACCO X RIMOLDI	89
F42	COLLARETTO	49	F272	COLLARETTO	55	F1110/D	ATTACCO X DURKOPP	89
F42B	COLLARETTO	49	F274	COLLARETTO	55	F1110/P	ATTACCO X PFAFF	89
F42H	COLLARETTO	49	F275	ACCOPPIATORE	62	F1110/K	ATTACCO X KANSAI	89
F43	COLLARETTO	48	F285	RIBATTITORE	59	F1110/J	ATTACCO X JUKI	89
F43B	COLLARETTO	48	F286	RIBATTITORE	60	F1111/R	ATTACCO X RIMOLDI	89
F43H	COLLARETTO	48	F301	ORLATORE	17	F1111/D	ATTACCO X DURKOPP	89
F44	COLLARETTO	47	F302	ORLATORE	17	F1111/P	ATTACCO X PFAFF	89
F44B	COLLARETTO	47	F315	RIBATTITORE	59	F1111/K	ATTACCO X KANSAI	89
F44H	COLLARETTO	47	F338	RIBATTITORE	60	F1111/J	ATTACCO X JUKI	89
F45	ORLATORE	6	F340	COLLARETTO	50	F1112	ATTACCO	89
F46	COLLARETTO	54	F342	COLLARETTO	49	F1114	ATTACCO	89
F46B	COLLARETTO	54	F344	COLLARETTO	47	F1120	ORLATORE	22
F47	COLLARETTO	54	F365	GUIDA PROFILO	70	F1125	ORLATORE	21
F47B	COLLARETTO	54	F385	PASSAELASTICO	73	F1125GA	ORLATORE	21
F48	COLLARETTO	54	F387	PASSAELASTICO	73	F1135	RIBATTITORE	56
F48B	COLLARETTO	54	F400	ORLATORE	9	F1140	GUIDA PROFILO	70
F49	COLLARETTO	54	F413	ORLATORE	9	F1174	ORLATORE	19
F50	BORDATORE	33	F414	PASSAELASTICO	75	F1182	PASSAELAST.	71
F50S	BORDATORE	33	F415	PASSAELASTICO	75	F1184	PASSAELAST.	72
F51L	ORLATORE	24	F416	PASSAELASTICO	75	F1185	PASSAELAST.	71
F51R	ORLATORE	24	F417	PASSAELASTICO	75	F1187	PASSAELAST.	74
F52	GUIDA FETTUCCE	86	F425	GUIDA PASSANTI	78	F1195	GUIDA PER BANDE	81
F53	GUIDA SPAGHETTI	85	F428	GUIDA PASSANTI	78	F1195B	GUIDA PER BANDE	81
F54	GUIDA SPAGHETTI	85	F435	BORDATORE	39	F1200	GUIDA PER BANDE	82
F58H	BORDATORE	29	F438	BORDATORE	39	F1240	FRENAGGIO	90
F60	BORDATORE	36	F445	GUIDA BRETELLE	80	F1240/L	LAMELLA	90
F60B	BORDATORE	36	F450	ORLATORE	14	F1240/M	MOLLA	90
F62	BORDATORE	35	F465	GUIDA STRISCE	80	F1240/V	VITE	90
F62B	BORDATORE	35	F465/995	LEVETTA	80	F1241	FRENAGGIO	90
F64	BORDATORE	34	F465/996	VITE	80	F1245	BORDATORE	44
F64B	BORDATORE	34	F470	ORLATORE	10	F1248	GUIDA PER BANDE	82
F65	ORLATORE	8	F485	GUIDA PER STRISCIA	84	F1265	BORDATORE	32
F66	GUIDA PASSANTI	76	F487B	BORDATORE	38	F1266	BORDATORE	32
F67	GUIDA PASSANTI	77	F495B	BORDATORE	38	F1292	PASSAELAST.	74
F68	GUIDA PASSANTI	77	F508	BORDATORE	29	F1295	BORDATORE	46
F69	GUIDA PASSANTI	76	F508PL	BORDATORE	30	F1296	BORDATORE	46
F69A	STAFFA	88	F508PP	BORDATORE	30	F2002	GUIDA PASSAELAST.	87
F70	ORLATORE	14	F516/10	SPINOTTO X JUKI	90	F5800	GUIDA PER BANDE	83
F72B	ORLATORE	11	F516/R	FRENAGGIO X RIM.	90	6190	FRENAGGIO	90
F72B/S	STAFFA	88	F516/D	FRENAGGIO X DURK.	90	F29000	BORDATORE	42
F72L	ORLATORE	11	F516/P	FRENAGGIO X PFAFF	90	F29002	BORDATORE	42
F72PI	ORLATORE	12	F516/K	FRENAGGIO X KANSAI	90	F31000	BORDATORE	44
F72PI/S	STAFFA	88	F516/J	FRENAGGIO X JUKI	90	F31001	BORDATORE	45
F73	ORLATORE	12	F517	FRENAGGIO	90	F31001R	ATTACCO	88
F74	ORLATORE	18	F519	FRENAGGIO	90	F31001S	ATTACCO	88
F75D	ORLATORE	4	F580	GUIDA	79	F31002	BORDATORE	45
F75DGA	ORLATORE	4	F585	GUIDA	79	F34000	BORDATORE	40
F75U	ORLATORE	1	F601	COLLARETTO	51	F34000A	STAFFA	88
F75UGA	ORLATORE	1	F602	COLLARETTO	51	F34001	BORDATORE	40
F76UGA	ORLATORE	2	F603	COLLARETTO	52	F34002	BORDATORE	41
F77	ORLATORE	25	F604	COLLARETTO	52	F121586	RIBATTITORE	57
F78	ORLATORE	16	F604A	STAFFA	88	F121586/S	SLITTA	57
F80	ORLATORE	7	F704	BORDATORE	43	F121586/V	VITE	57, 58
F80C	ORLATORE	7	F704A	STAFFA	88	N121586	RIBATTITORE	58
F85	ORLATORE	8	F705	BORDATORE	43	N121586/S	SLITTA	58
F91	ORLATORE	16	F815	ORLATORE	20	R121586	RIBATTITORE	58
F95	ORLATORE	25	F1015	GUIDA PROFILO	69	R121586/S	SLITTA	58
F100	BORDATORE	26	F1020	GUIDA PROFILO	69	F121757	RIBATTITORE	57
F100A	STAFFA	88	F1025	GUIDA PROFILO	65	F121757/S	SLITTA	57
F100PL	BORDATORE	27	F1030	GUIDA PROFILO	65	F204075	GUIDA BATTUTA	87
F100S	BORDATORE	26	F1035	GUIDA PROFILO	68	F310006	GUIDA BATTUTA	87
F105	ORLATORE	13	F1040	GUIDA PROFILO	68	F310012	GUIDA BATTUTA	87
F105GA	ORLATORE	13	F1045	GUIDA PROFILO	64	F310013	GUIDA BATTUTA	87
F105GA/S	STAFFA	88	F1050	GUIDA PROFILO	64	F310015	GUIDA BATTUTA	87
F109	GUIDA	83	F1051	ACCOPPIATORE	63	F310040	GUIDA BATTUTA	87
F115	ORLATORE	10	F1055	GUIDA	84	F490361	RIBATTITORE	56
F125	ORLATORE	23	F1060	GUIDA PROFILO	66			
F145	ACCOPPIATORE	62	F1065	GUIDA PROFILO	66			
F150D	RIBATTITORE	61	F1070	GUIDA PROFILO	67			
F150S	RIBATTITORE	61	F1081	BORDATORE	31			
F153	GUIDA SPAGHETTI	86	F1082	BORDATORE	27			
F165	BORDATORE	31	F1083	BORDATORE	28			
F172	ORLATORE	20	F1086	ORLATORE	5			
F174	ORLATORE	19	F1087	ORLATORE	5			
F175	ORLATORE	18	F1090	ARRICCIATORE	87			
F175U	ORLATORE	2	F1100	ATTACCO	89			
F180	ORLATORE	22	F1102	ATTACCO	89			
F185B	BORDATORE	37	F1103	ATTACCO	89			
F186B	BORDATORE	37	F1104	ATTACCO	89			